

# **Solving noise problems in Modern Radio systems**

By Bryan Ackerly, VK3YNG

## **Abstract**

In recent times there has been a substantial increase in the use of digital technology in radio systems. This sort of technology has been slow to catch on in amateur circles due partially to the fear and misunderstanding of the noise problems associated with mixing RF systems with digital technology. Many amateurs to date have avoided the mixture of these technologies. In contrast survival in the commercial world requires it to battle with these issues on a regular basis.

This paper draws on knowledge gained on both commercial and amateur projects that successfully combine these technologies and indicates methods that can be used to produce working designs.

## **1. Introduction**

### **Why is noise important?**

High speed digital processing systems are becoming common components in today's radio systems. Increasingly the "smarts" of a radio systems are being used for more than control of displays and PLL's etc. but are being used for modulation and demodulation at baseband or IF frequencies. Often done using Digital Signal Processors (DSP) or programmable logic, these systems allow for almost limitless modulation/demodulation capability. This is the basis of many new software defined radios. However, the additional advantages of using this technology is diminished if the noise it generates limits the performance of the radio system it interfaces with.

In the commercial world, radio systems exist where all components are mounted on one side of a multilayer board including DSPs and switching power supplies with only VCO and overall box shielding. Such systems not only perform the radios functions without internal interference problems, but are also required to pass some rigorous radiated and conducted emission tests. Systems are also now emerging where complete digital transceiver systems are being fabricated on single chips. The combining of digital and radio technologies can easily coexist as long as the noise and isolation requirements of both systems are properly understood.

## **2. Types of Noise**

### **2.1 Radiated**

Radiated noise is probably the most commonly discussed in amateur circles as it is often assumed that this is what a receivers antenna will pick up. It is often assumed that components (leads and the body of the components themselves) are responsible for most of this. With modern surface mount components used on printed circuits with continuous ground planes, direct radiation is usually very low in level. Some inductive components like wirewound inductors and ferrite beads in particular can be responsible for radiated emissions but even these are becoming so small that it becomes rather difficult to pick up any radiated field from an appreciable distance. Radiated noise tends to come from other less obvious sources in today's designs.

***Republished with permission from the GippsTech'02 Conference, Australia, 2002***

## **2.2 Conducted Noise**

Of all the types of noise and interference this is normally the easiest to measure and control. This is the noise that is conducted between parts of the circuit by directly connected signals or power connections. Series and shunt filtering (bypassing) or a combination of both are normally used to control this noise. Apart from a few often overlooked properties of commonly used components, these techniques can be used to control conducted noise problems quite effectively. The operation of these solutions can be easily and accurately simulated with modern and freely available computer simulation tools.

## **2.3 Ground or supply induced Noise**

This type of noise is possibly the least understood not just by amateurs but also in the commercial world. The ground symbol makes for nice and readable schematic diagrams but no two ground or supply points on a printed circuit board or even a chassis can be considered the same. Gaps in metalwork and cuts in PCB ground planes can contribute considerable amounts of radiation particularly as frequencies or edge rates increase. It also becomes very difficult to control this noise once it has “got out” and attempts to shield it are often unrewarding. This is usually because the shield itself only serves to re-radiate the noise if its source is not properly understood and contained. A practical example of this is given later.

In many cases, noise which is considered to be due to direct radiation from components is more often than not caused by a ground differential, slot or gap.

## **3. Methods of Noise reduction**

### **3.1 Shielding – the Faraday Cage.**

Shielding is probably the most talked about option for solving noise and interference issues. It is possibly also one of the most misunderstood and is often used to cover up a basic design problem.

For a shield to work effectively, it MUST be complete. A shield with open ends is not much of a shield at all. For example a recent piece of equipment with a known problem with a radiated 900MHz harmonic in a power amplifier was shielded using a can approximately 40x90x10mm. The shield was grounded with screws to the PCB at 20mm intervals on its long side and the 40mm ends had a slight gap (about 2mm) to allow PCB tracks to exit. This shield only contributed a 2dB reduction in the radiated harmonic. Additional grounding to the PCB mid way along the gap on the 40mm ends resulted in a reduction of a further 13dB in the radiated harmonic!

The case above is interesting. There are a number of texts that mention that for a shield to work effectively, a “rule of thumb” says it must be stitched at intervals of less than  $\frac{1}{2}$  wavelength. The 40mm gap is only 0.12 wavelengths. Even so it did contribute to the level of harmonic possibly because of the large circulating currents in this case. Testing with a current probe revealed that the harmonic currents were coupling into the shield itself via differentials in the PCB ground, even though it was a solid copper plane. Thus the shield was actually performing the job of a less than efficient radiator which then allowed it to couple into all other parts of the equipment giving the effect that the harmonic was “coming from everywhere”. Such examples are quite common in radio equipment and if not properly understood can result in some very elaborate and expensive solutions to try and contain the emission that could have otherwise been more easily solved.

A near field current probe is a very useful tool in finding the source of these problems. In its simplest form a small surface mount inductor glued into the end of an old ball point pen case fed with a short length of RG174 coax can make a very useful piece of test equipment. A 1008 inductor of around

100nH-500nH is generally suitable for VHF through low microwave work. For testing receiver susceptibility, you can feed the inductor from a signal generator.

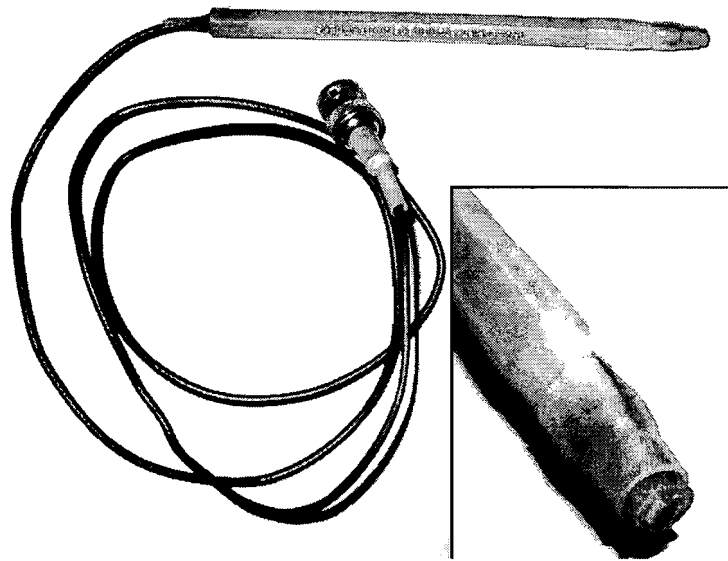

**Figure 1 – A home made inductive probe.**

**(Note the line drawn near the tip to indicate the plane of the coil)**

Trying to contain an issue like this can become very difficult as the equipment housing becomes larger. Joins in metalwork, interconnecting cables, the case itself and even the front panel controls will become radiators and/or receivers of noise. Even the position of mounting screws can be important as they can form a feedpoint into the case and use it as an inefficient antenna. It is well worth the effort to try to contain the problem at its source instead of trying to battle with it once it has got out into virtually all other parts of the equipment.

The “rule of thumb” of half wavelength only holds true if the radiating source is a reasonable distance from the shield itself and is effectively isolated from it. With an application like a PCB mounted RF Power Amplifier, and many other real examples of RF circuit assemblies this is rarely the case.

## **3.2 Series Filtering**

This type of filtering usually makes use of resistors, ferrite beads or inductive elements.

### **3.2.1 Resistors:**

Surface mounted resistors of low values are possibly the closest to ideal for series filtering well into the microwave region. They are useful where signal currents are low. Beware though of raising the effective impedance of connections too much as this can result in lower frequency noise susceptibility. Generally values between 10 and 1000 ohms are used and usually in conjunction with shunt capacitance. This is possibly the cheapest and simplest filtering element for lower speed signalling and audio lines. Parasitic capacitance of surface mount resistors is usually within the order of 0.06pf.

### **3.2.2 Inductors:**

“Reactance for an inductor increases with frequency so therefore bigger it is the better.”

Unfortunately it is not quite that easy. Inductors are useful over a reasonable range of frequencies but

their highest frequency of effective inductance is limited by self resonance. The impedance at resonance is usually quite high and this can be used to good effect if only one band of frequencies need to be suppressed.

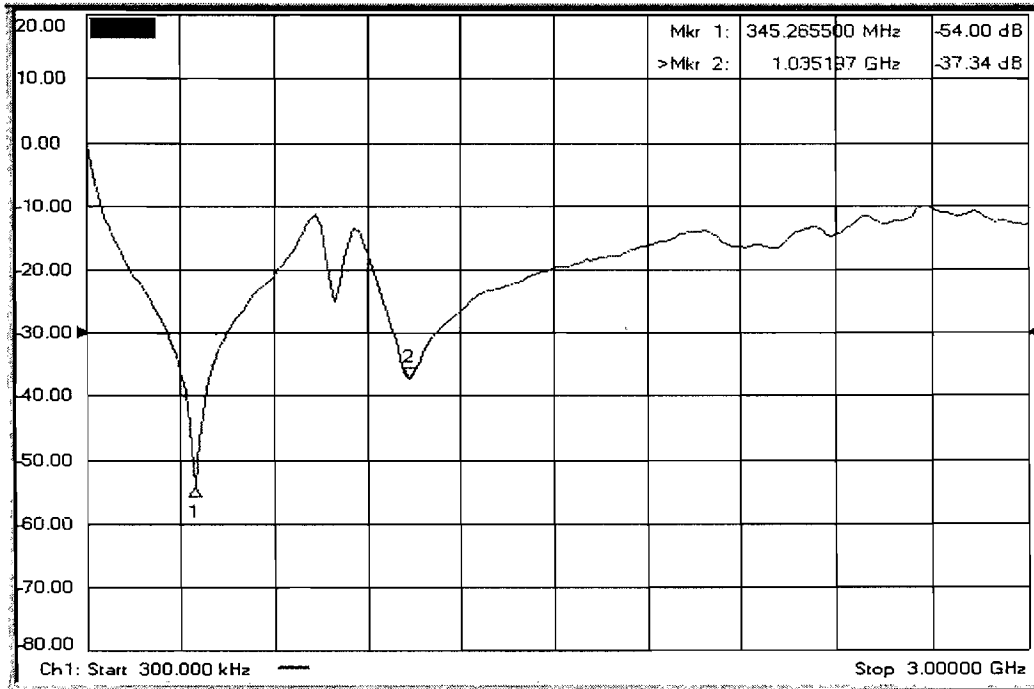

**Figure 2 – Series transmission loss of a Coilcraft 1uH, 1008CS Inductor. (50ohm system)**

Note in the above case the transmission loss at resonance is more than 50dB, but the attenuation drops off significantly above and below this frequency. This particular inductor also shows a secondary resonance at just above 1GHz. The behaviour of inductors above the first resonance can become quite complex and unpredictable.

For higher frequencies, thin lengths of PCB track can also be considered used as inductors and their operation is easily simulated with many computer modelling tools.

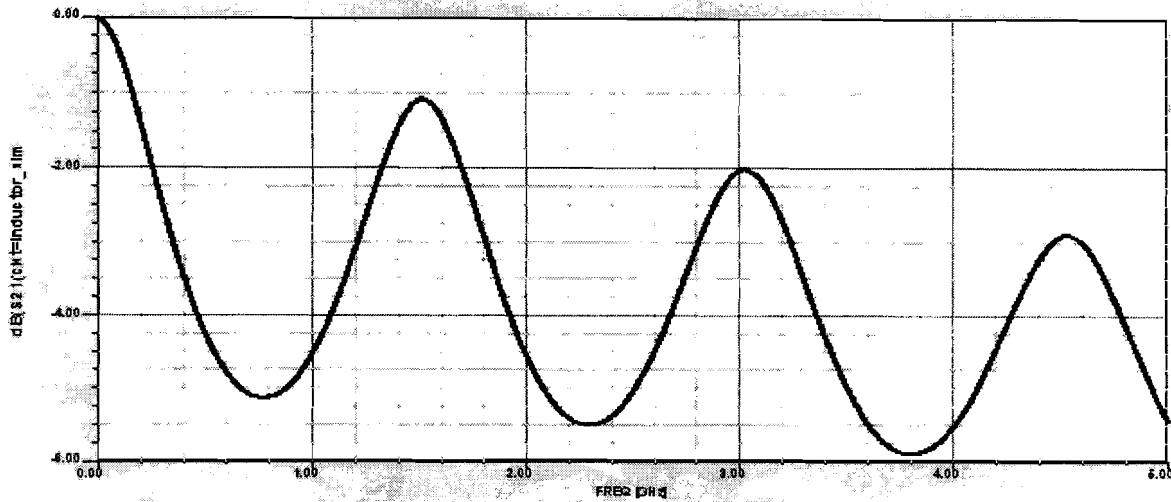

Figure 3 –

**Simulated insertion loss plot of a track  
0.2mm x60mm on 1.6mm FR4 PCB**

### 3.2.3 Ferrite Beads:

Ferrite beads are often hailed as a “cure all”. They are a broadband (low Q) series filtering device which is available with varying characteristics but it must be kept in mind that the penalty for low Q is low impedance. Where an inductor at self resonance can have a reactance of thousands of ohms, the ferrite bead normally only approaches the tens or hundreds. Using one of these devices on its own is only really useful if a few decibels of attenuation are required to pass marginal EMC compliance. Beads and inductors are often required for power supply filtering where a good ground reference plane is not available.

**Figure 4 - BLM31A700 RF Bead measured transmission loss  
(in 50 ohm system)**

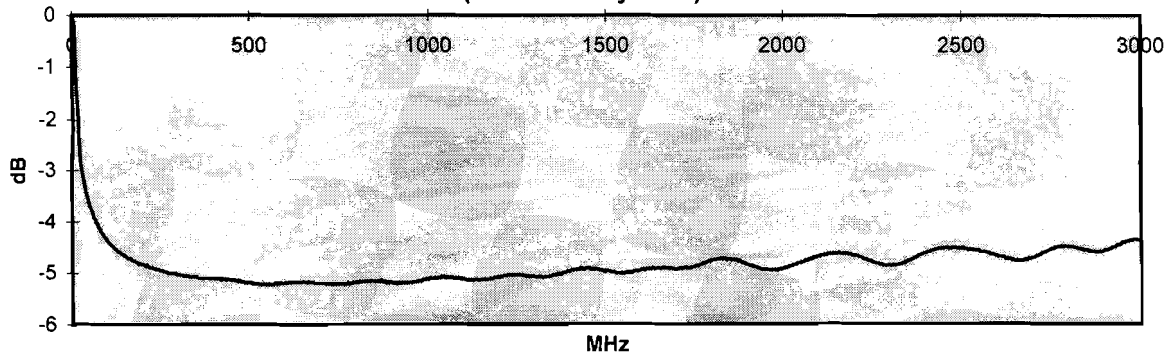

There is

one case where beads are especially useful and that is when used in conjunction with shunt capacitors to damp capacitor resonances. This can provide very good broadband filtering. An example of this is given in the references under “Simulation Tools, Real Components and Limitations” section 7.5, figure 8.

### 3.3 Bypassing

Shunt bypassing is possibly the most used technique to try to contain conducted noise.

Care must be taken when using parallel bypassing that the loop area involved is kept relatively small. Not only does the additional track length decrease the effective series resonance frequency but the increased loop area can generate increases in radiated noise.

Where power planes are involved, components should be connected directly to the planes by the shortest possible connections. Bypass capacitors should be distributed across the plane close to the faster components, but not necessarily right next to them. The spacing between power planes should be as close as possible. Core materials of 0.25mm or less are now possible by many PCB manufacturers without additional cost. This is because bypassing capacitors have negligible effect past about 100MHz when a power plane is involved. The power plane provides a high quality capacitance which provides very low effective series resistance and inductance. An example of this is provided later. Avoid putting splits in power or ground planes unless you are absolutely sure you know what you are doing. In many cases if a plane split is necessary to solve a problem, chances are the problem can usually be solved by better analysis of the groupings of circuit functions.

### **3.4 Cancellation**

In theory, cancellation can be used where a signal coming one source is mixed with another which is exactly 180 degrees out of phase. This is nearly impossible to achieve unless the “noise” is at one fairly low single frequency. This is rarely the case.

It is worth mentioning cancellation for another reason. Sometimes when trying different solutions, particularly on a rather “RF hot” structure, the level of an emission may increase and you may get the impression that a particular change is detrimental. If there is more than one signal source involved of similar levels and the change may have actually resulted in the reduction of one of these sources. This can often happen in a multistage power amplifier for example. Likewise a change may also result in a substantial reduction until operation frequency or power level or some other operating parameter has changed. It can take quite some time to gain understanding of this issue. It is also the reason why cut and try solutions can often result in the wrong conclusions.

## **4. Getting the best result**

### **4.1 Understanding the problem**

The most important issue is to first try and understand the cause of the problem. Trying to contain a noise issue that is not fully understood can result in severely over designed arrangements that may only partially solve the problem. A little bit of time spent properly analysing and understanding a noise problem can result in a lot better solution than trying to patch up a problem that has already been created. Adding bypass capacitors to a radiating ground, for example, will not offer much of a solution.

Try to avoid the “cut and try” method with a view of trying to solve the problem. This may be useful to understand an issue but not necessarily to fix it. The most important thing is to identify the problem and then if it makes logical sense, the right method of suppression or containment can be designed and implemented.

### **4.2 Clock rates or edge rates?**

There is a lot of confusion amongst amateurs about clock rates. It is often believed that noise and radiation increases with increasing digital clock rates. A comment that is often heard is “it is only

operating at x MHz!”. Consider the following plot which is the measured spectrum of a 5V ACMOS buffer driven from a 64MHz clock.

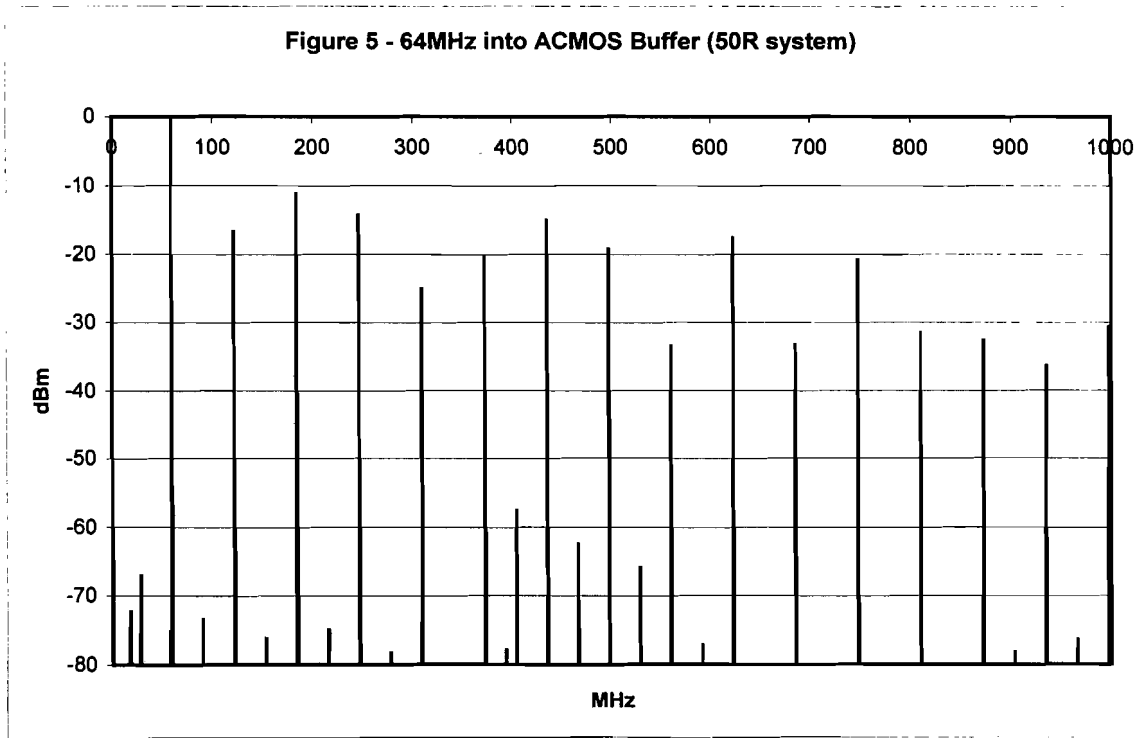

Note the levels and distribution of the harmonics. The same circuit was then modified to run at a quarter of the frequency.

Figure 6 - 16MHz into AC MOS buffer (50R system)

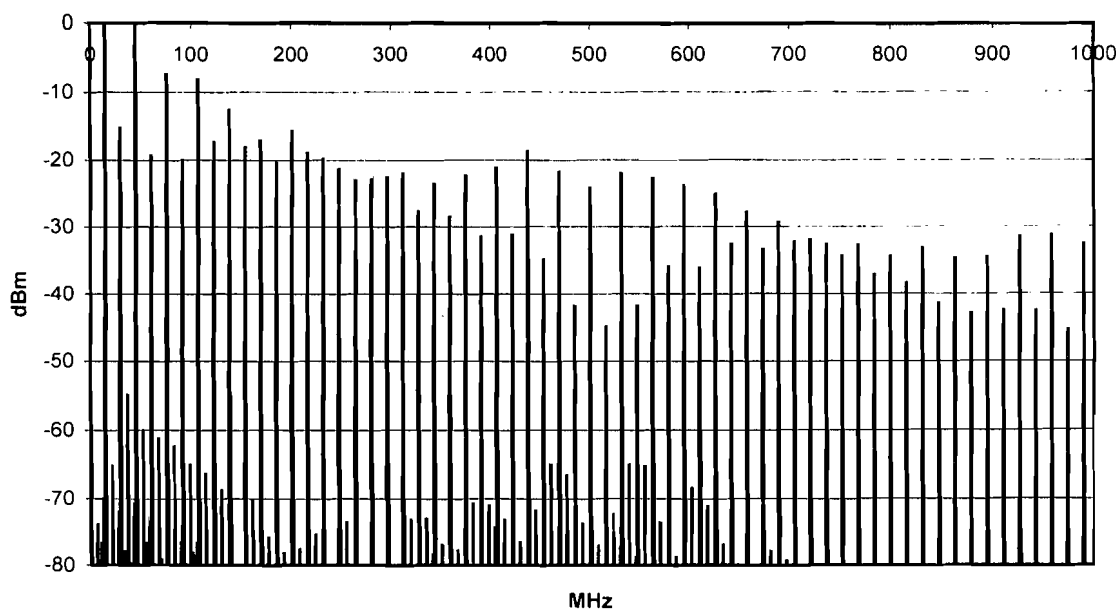

The above plot shows that the reduction in clock rate does very little to change the levels of the harmonics. If anything it shows that there are lots more of them. This is a typical problem in a digital system especially containing clock distribution and parallel busses. There are lots of division ratios in operation the spectrum becomes very complex indeed. If these signals are allowed to radiate they will be very hard to suppress.

The important issue here is that the harmonic spectra has little to do with the clock rate. If the waveform was essentially sinusoidal, harmonic levels would be very low. But in this case the signals are square waves with rise and fall times below 1 nanosecond which are very rich in harmonics. Such edge rates are common in today's digital components.

It cannot be overstated here that what is important here is that the harmonics are caused by the rise and fall time or EDGE RATE of the signal and have very little to do with the clock rate involved.

To illustrate the effect of the edge rate on the harmonic spectrum, the following plot shows the output of the same system with a series 10 ohm resistance shunted by 100pf to ground.



Figure 7 - 16MHz into AC MOS buffer, filtered by 10R and 100pF RC Filter  
(50R system)

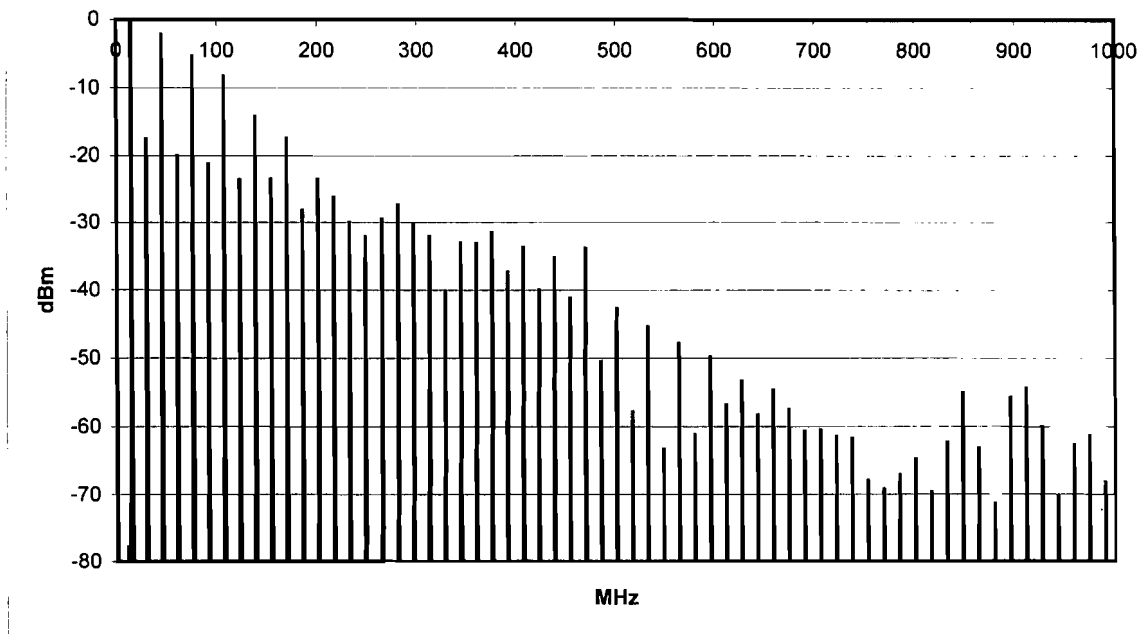

The above shows that while there is minimal effect on the lower frequency harmonics, in the UHF to microwave region harmonics are significantly attenuated due to the reduced edge rate of the signal.

Ferrite beads are often used to effect series filters on supply lines. The following illustrates the effect of placing a ferrite bead in series with the clock output signal.

Figure 8 -16MHz into AC MOS buffer, filtered by BLM41 Ferrite Bead  
(50R system)

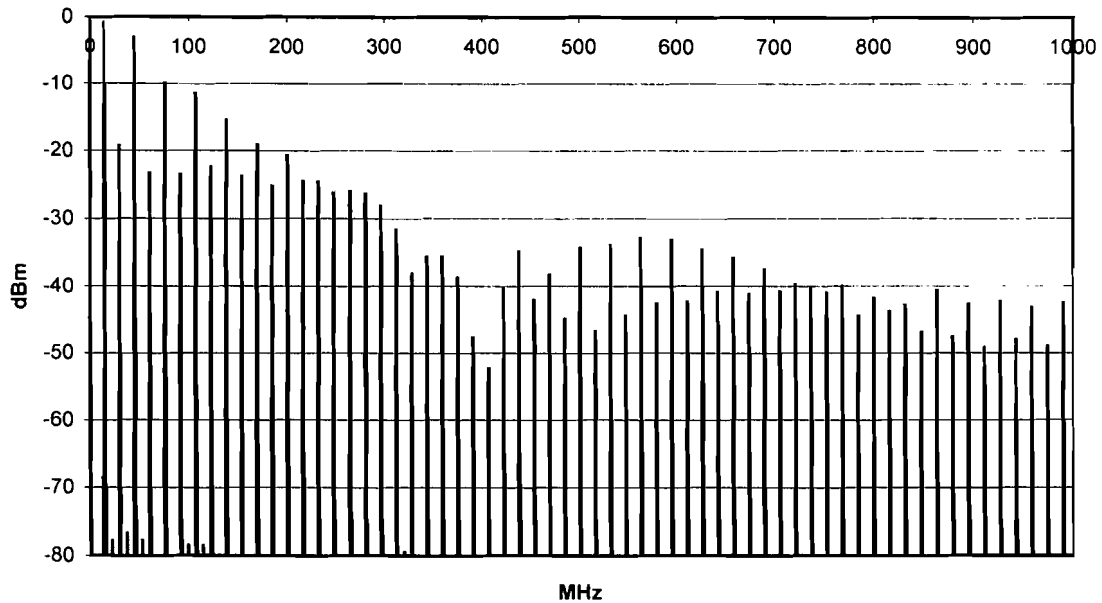

As can be seen the ferrite bead has provided some attenuation past about 200MHz. It is effectively around 10dB which is not a real lot, but may be suitable in some cases.

More attenuation can usually be gained by adding some shunt capacitance after the bead. The following shows this effect.

Figure 9- 16MHz into AC MOS buffer, filtered by BLM41 bead and 100pF cap  
(50R system)

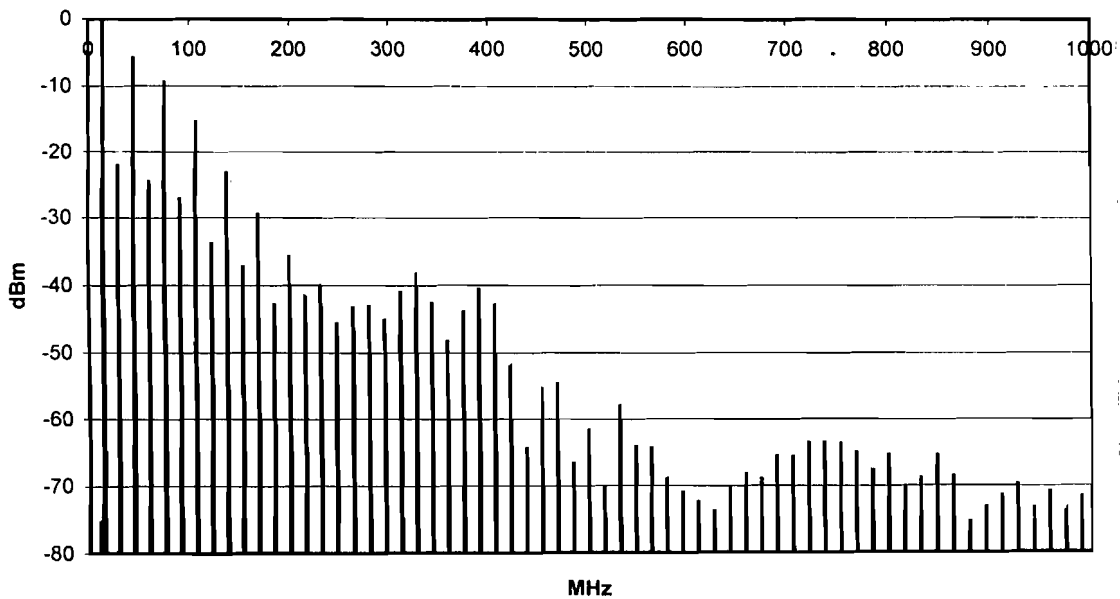

Note that the attenuation is significantly greater than using the bead on its own. It is also much better than when the 10 ohm resistor was used as the series element, particularly in the UHF region. Note also that the attenuation is relatively constant from this point on.

The advantage here is that the loss at DC is relatively small with the bead and a reasonable amount of attenuation is available with this combination, a lot better than with either component on its own.

Another situation where beads are particularly useful is in “broadbanding” the filtering by paralleling capacitors. In this case a second bead is used to allow a 1nF to also be used as part of the filter. The bead suppresses the impedance hole that would be created if the capacitors were directly placed in parallel.

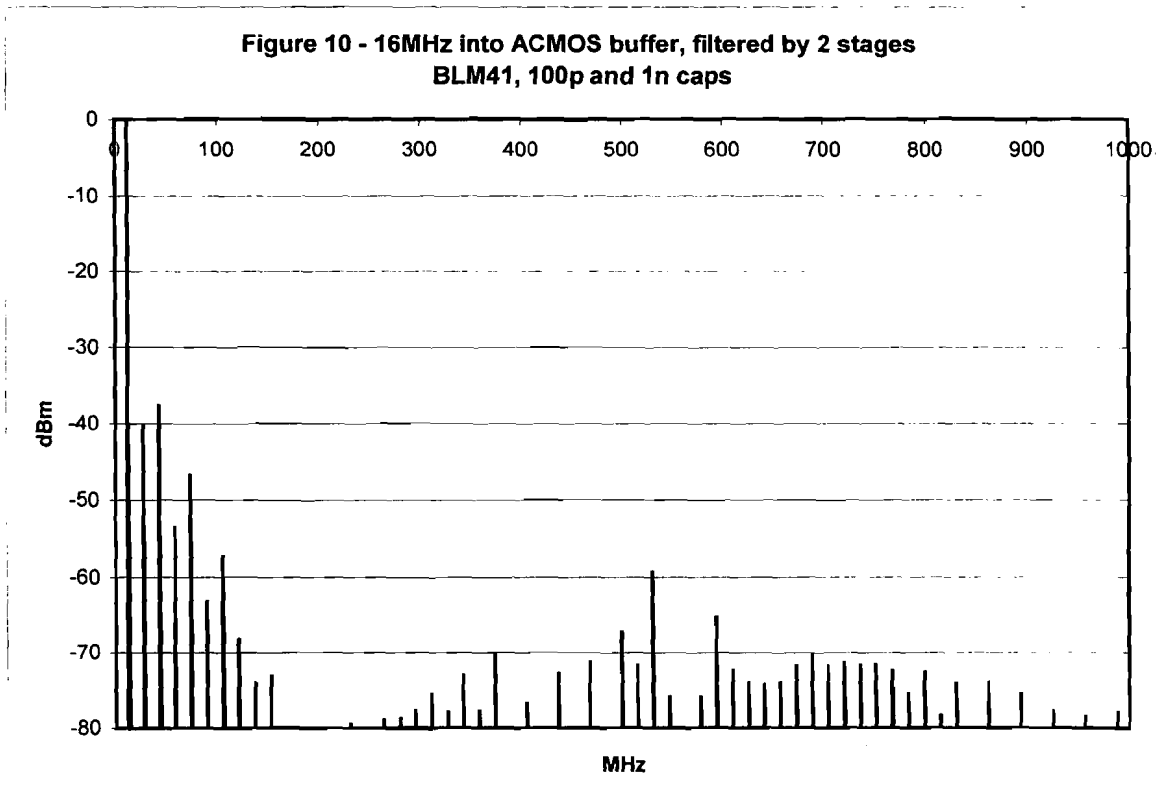

The above plot shows that significant attenuation is available past about 100MHz and that the filtering is effectively broad band. The extra attenuation due to the series resonance of the 1nF NPO capacitor at around 180MHz can easily be seen as this capacitor has a much lower ESR than the 100pf capacitor.

### 4.3 Transmission lines

Essentially any line that runs parallel to an uninterrupted ground or supply trace can be considered a transmission line. Normally the radiation from a properly terminated transmission line is minimal. What there is of radiated fields can be minimised by using thinner substrates or by sandwiching the transmission line in between uninterrupted ground and/or supply planes. In any case, radiation or pickup by transmission lines can be minimised by keeping them well terminated and as short as possible.

#### **4.4 Series Termination**

Series termination is effected by putting a resistor in series with the output of a driver of a transmission line or PCB track. The resistor is chosen such that the combined output impedance of the driver itself plus the resistor equals the impedance of the track. This is the optimum case which should eliminate any over/undershoot or ringing. Increasing the resistor further will limit the signalling rate as the track and gate input capacitance start to become dominant. In some cases this can be useful but be careful not to exceed device maximum transitions times.

#### **4.5 Parallel Termination**

Parallel termination is used at the far end of a constant impedance track. Most modern integrated circuit inputs can be modelled as high resistance capacitive loads. Using a Thevenin equivalent network which matches the line impedance of the track can help eliminate line reflections and unwanted radiation. A full analysis is beyond the scope of this paper.

#### **4.6 Radiating elements + Plane splits**

A toggling line that does not run parallel to a ground or supply plane or passes over a split in a plane of any length WILL radiate. This is because the return currents pass around the split in the ground plane and effectively a slot antenna is formed. The need for a totally uninterrupted ground and/or supply plane for a digital or RF design cannot be overstated. Plane splits should be avoided as much as possible as they often cause more problems than they solve. In most cases a problem that required a plane split could have been solved by more appropriate layout.

#### **4.7 connecting leads**

External connecting leads can form radiating elements if their exit point is not tied via a good RF connection to the case. If the closest low impedance ground is inside the equipment housing and there is ground differentials or a lot of internal RF radiation, the exiting cables may radiate or pick up interference.

#### **4.8 Through hole components**

These components are gradually being replaced with surface mount devices and for good reason. The leads of many passive components possess considerable amounts of inductance and due to their large size are quite capable of radiating noise especially in the UHF and microwave region. Variable lead lengths also make it very difficult to accurately simulate these components for use at other than HF frequencies.

#### **4.9 The Power Subsystem**

The power subsystem is often the most ignored and under-engineered noise source. There is a lot of misinformation about power supply bypassing that dates back many years. Many of the “rules of thumb” that were used many years ago simply do not hold true with modern systems. Fast edge rates of modern digital components put demands on the power subsystem that conventional bypassing techniques just don’t address. A full analysis of power subsystem design is beyond the scope of this paper but a brief analysis for one system is presented here. There are a number of more recent articles that provide an extremely good insight into the problems involved and how to address them. These articles are a MUST READ for anyone mixing RF and digital technology.

A sample radio system comprising of a processor board and an RF board had been designed and a sweep of the receiver was done with a dummy load on the antenna port. Careful attention was paid to all signals exiting from this board and all were fitted with surface mounting resistor and capacitor networks to low pass filter all of the I/O lines.

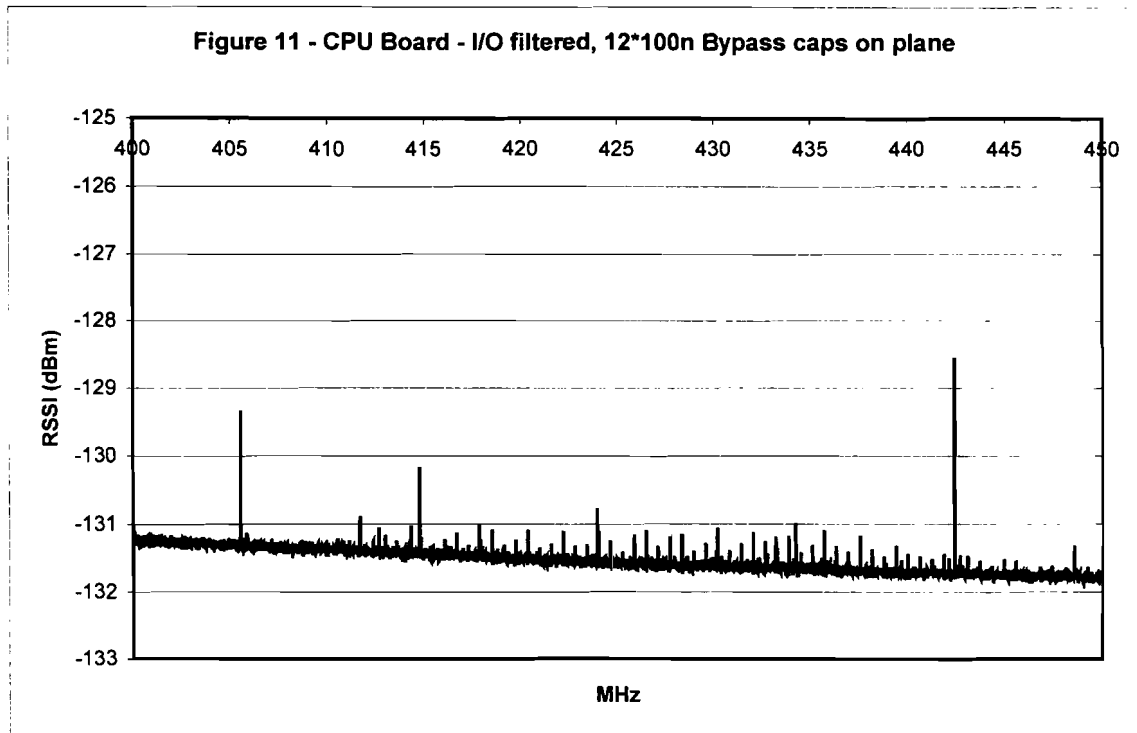

As can be seen above, there are a number of spurs that sit just above the noise floor. The prominent spurs were harmonics of a Digital Signal Processor. This was the only fast edge rate component used on the board. There were no signs of noise from the other slower edge rate digital components.

The remaining lower level spurs were caused by a switching power supply on the Radio main board and for the purpose of this analysis were ignored. An investigation into tackling them is beyond the scope of this paper, but it is worth mentioning that they were caused by ground plane differentials and not directly conducted or radiated noise.

An analysis of the major spurs revealed that the noise was caused by differential ground currents across the processor board. Even though care was taken that there was only one ground exit point (multiple ground and/or signal locations on a board like this would have been a disaster!) and the supplies were well filtered, there was still enough ground differential such that low pass filters on the I/O signals were effectively conducting the noise back out into the rest of the radio.

An analysis of the power subsystem was done using a simple simulation. The power plane capacitance was measured at 800pf. For simple analysis this can be modelled as a single capacitor with no series resistance or inductance.

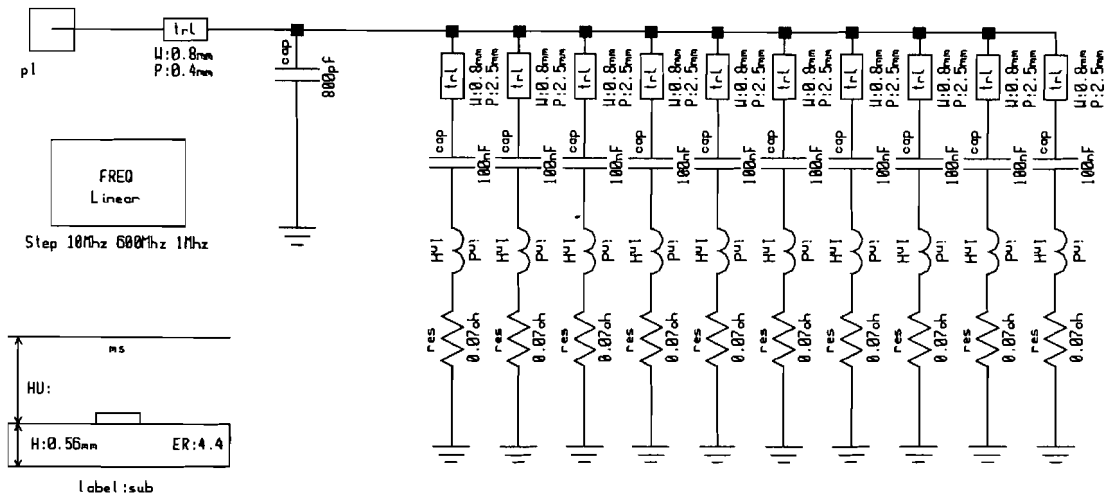

**Figure 12: Circuit used for simulation. The circuit takes into account track length to connect capacitors.**

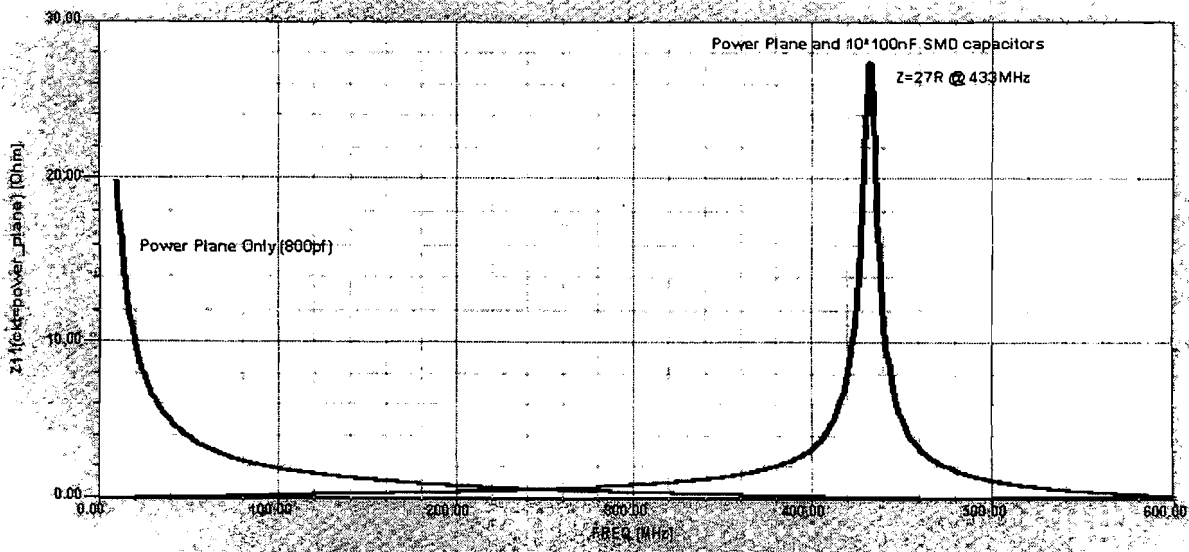

**Figure 13 – Power Plane impedance simulation**

As can be seen above there is a considerable peak in the impedance of the power plane at around 430MHz. In fact the filtering provided by the power plane is considerably worse between about 250 and 600MHz than just the power plane alone! Some bulk Low ESR capacitance was needed to overcome the series filtering of the supplies and to replenish the plane from some of the slower rise time components, so eliminating the bypass capacitors altogether and just relying on the plane was not feasible in this case. It needs to be pointed out that there are quite a few large high quality digital products that rely only the plane only and a couple of bulk storage capacitors. These products pass all EMC and performance specs without any problems – all from proper power plane engineering. This also results in the side benefit of lower production costs.

To confirm the above simulation a plot of the impedance was done with a Vector Network analyser.

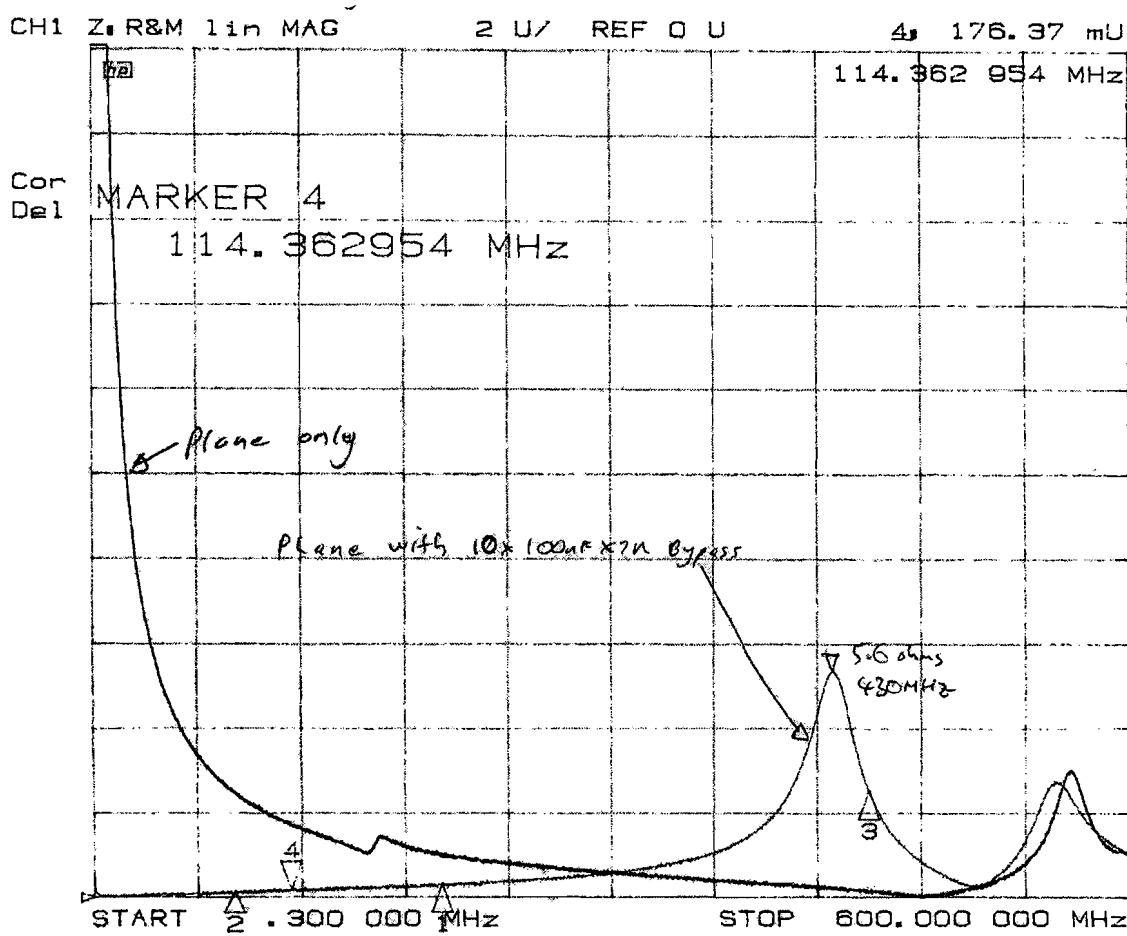

**Figure 14: Network Analyser Plot of Measured unmodified power plane Impedance**

The analyser plot shows that the results agree quite well with the simulation. The lower peak impedance was likely due to the distribution of the bypass capacitors and the ESR of the power plane which was assumed zero. The second peak just before 600MHz is most likely a board or measurement jig resonance. The slight kink in the “plane only” trace at around 160MHz is due to an analyser calibration fault and should be ignored.

The question was then what to do about the impedance hole and where it came from.

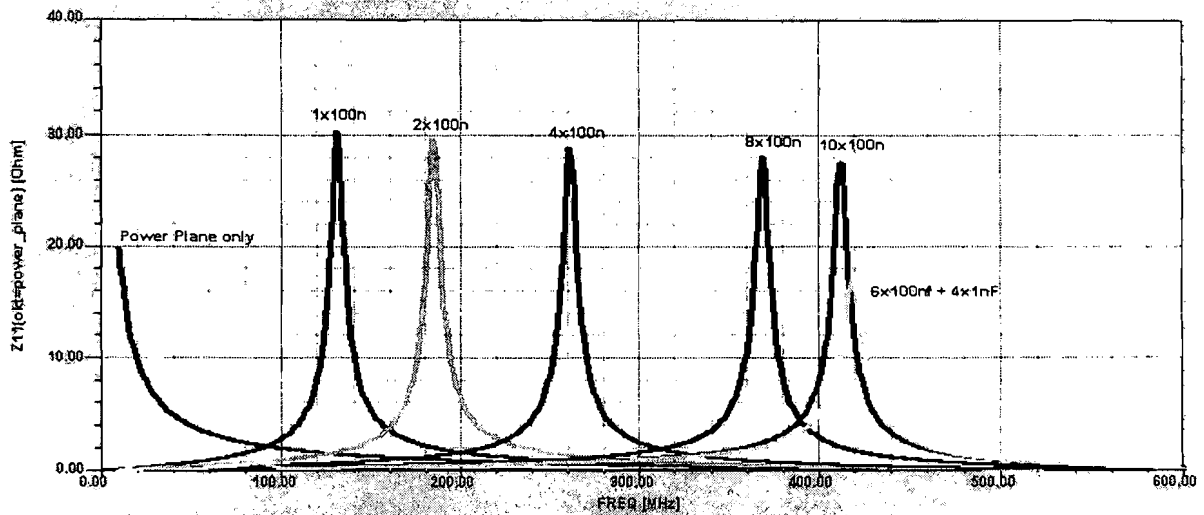
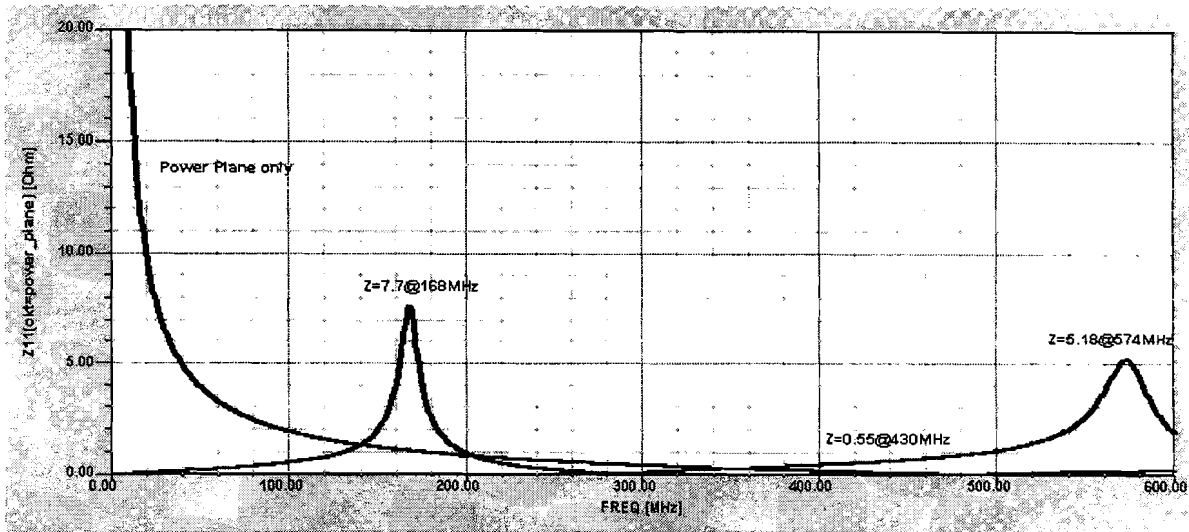

**Figure 15: Simulation of power plane impedance with bypass capacitor combinations**

The above plot is a simulation of the power plane with 1, 2, 4, 8 and 10 bypass capacitors. As can be seen, the impedance hole is present with any value of capacitance. It is caused by the parallel resonance formed by the plane capacitance and the effective series inductance of the bypassing capacitors.

It is believed by some that you can “broadband” the bypassing by using two or more different capacitor values. Replacing some of the capacitors with 1nF instead of 100nF results in a very slight increase in frequency of the resonance hole and a reduction of its level. The reduction of the level of the impedance is not due to the change in capacitance but due to the increase of its ESR. If the 1nF capacitor had the same ESR the impedance hole would be almost the same level, although it would still be shifted very slightly high in frequency. There is however a very subtle effect of a slight secondary resonance hole at just under 100MHz. The next simulation shows the effect of taking this concept a little further.





**Figure 16: Modified power plane bypassing**

In the above plot there were 4 x 100nF X7R and 9 x 100pf NPO capacitors used. As can be seen there are now two impedance holes but their levels are somewhat lower than the single peak. The lower peak occurs as the result of the parallel resonance formed by the inductance of the 100n capacitors resonating with the 100pf capacitors. What is of most importance here though is that the impedance at 430MHz is now only about 0.55 ohms. While still more than the plane on its own, the result is still quite usable. This arrangement was verified on a network analyser.

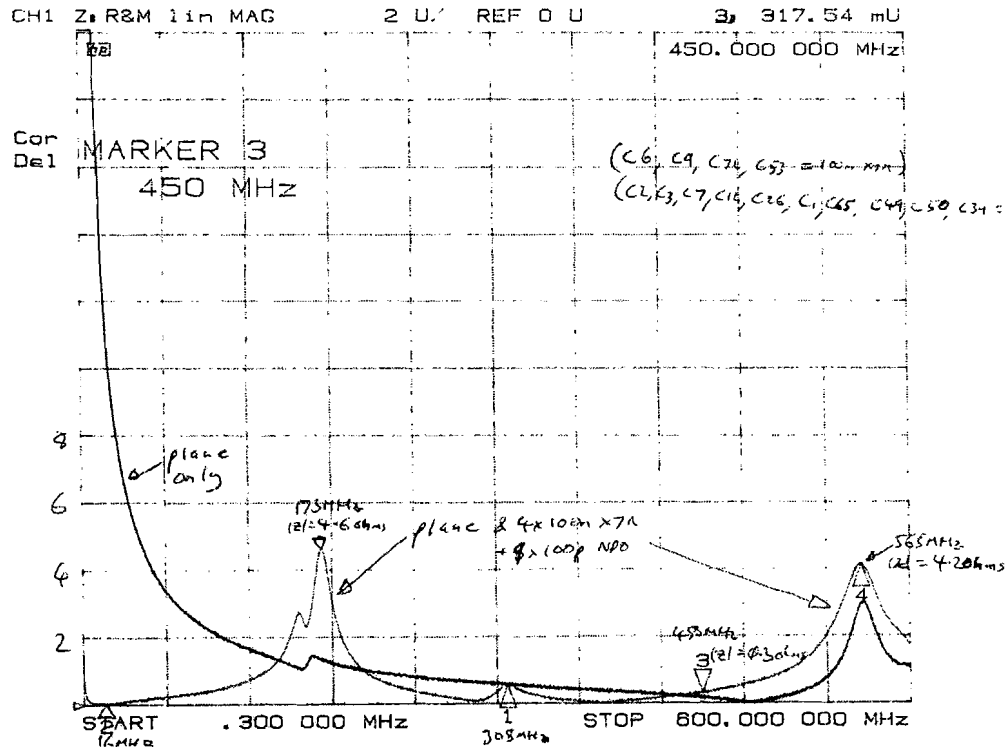

**Figure 17: Network Analyser plot of modified plane impedance.**

As can be seen the results of the practical measurement agree with the simulation fairly well. Impedances are all slightly below the simulation once again assumed to be because the plane was lossless in the simulation. Now that the plane appears to have a reasonable bypassing capability at the frequency of interest a sweep of the receiver was performed with this modified processor board.

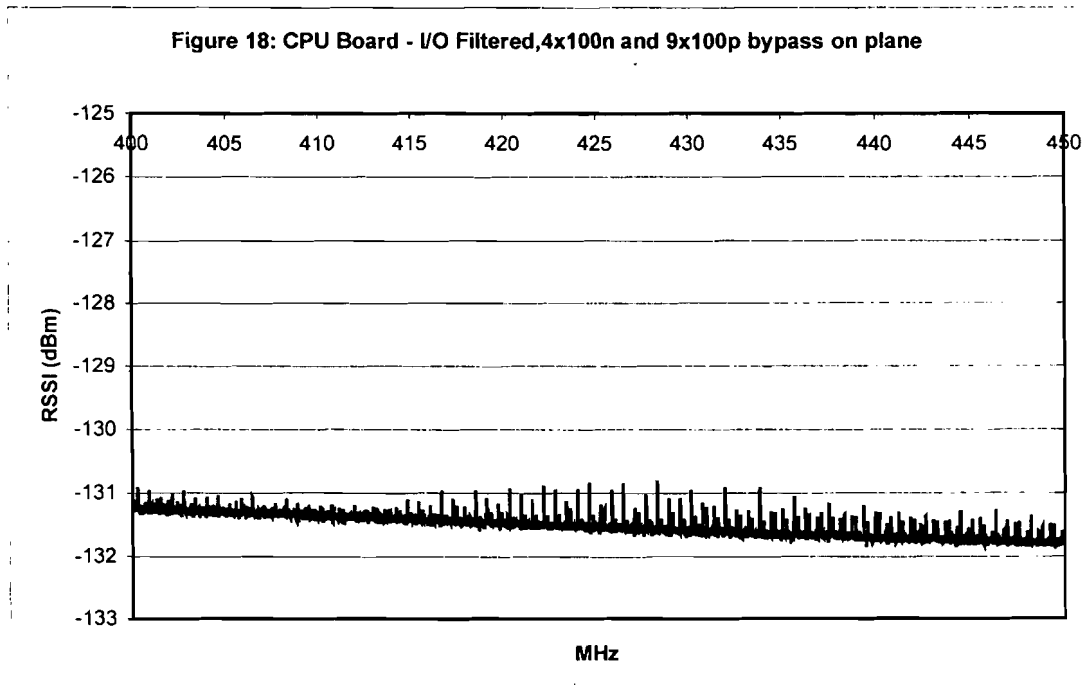

As can be seen the harmonics from the DSP are now gone! We have a clean noise floor.

To take this one step further, the spacing between the power planes was reduced to 0.2mm. This effectively doubles the capacitance.

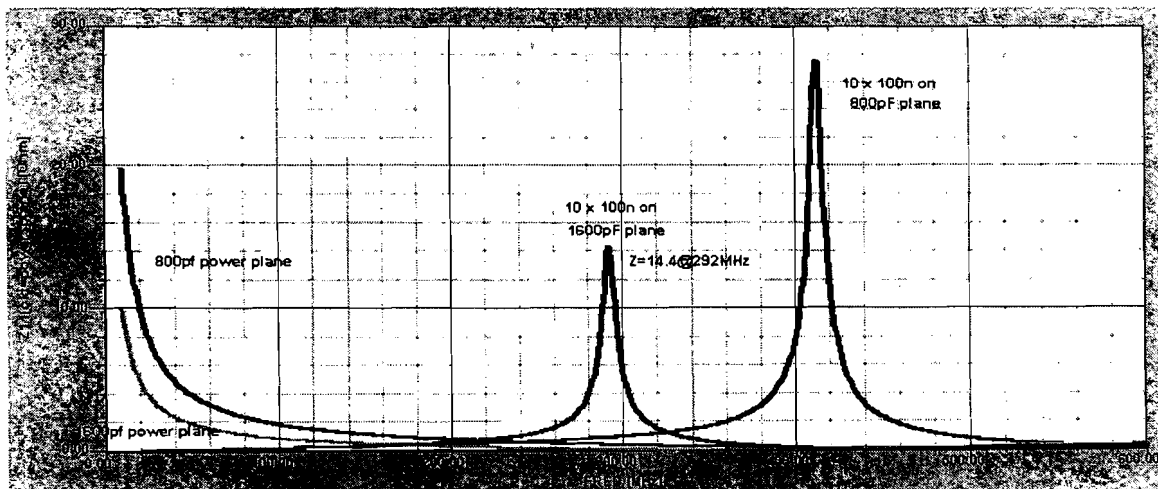
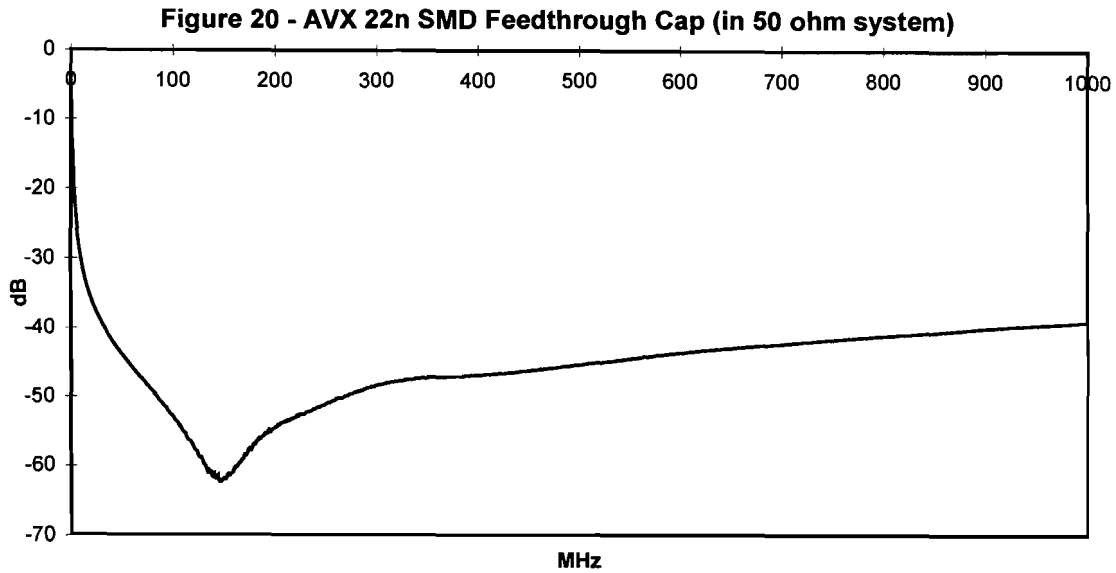

Figure 19: Comparison of two power plane core thicknesses

This figure shows that by reducing the plane spacing, the resonance caused by the 100n capacitors is shifted down in frequency and the depth of the impedance hole is reduced considerably. Of more importance is that the impedance of the plane is reduced to 0.06 ohms at 430MHz for the plane with capacitors which is an order of magnitude lower than the previous solution. Without the bypass capacitors the impedance at 430MHz was 0.02 ohms. This was used as the final solution.

#### 4.10 Feedthrough Capacitors



The above graph is an actual measurement of an AVX 22nF SMD feedthrough capacitor taken on a 50 ohm network analyser. Note the resonance occurring at 150MHz making this capacitor very useful at two metres. By comparison a conventional 0805 capacitor of the same value would exhibit a self resonance at about 35MHz with a similar attenuation (about 60dB). The attenuation falls off at either side of resonance and only exhibits a little over 10dB of attenuation at 1GHz. By comparison the feedthrough capacitor still exhibited around 40dB attenuation at this frequency.

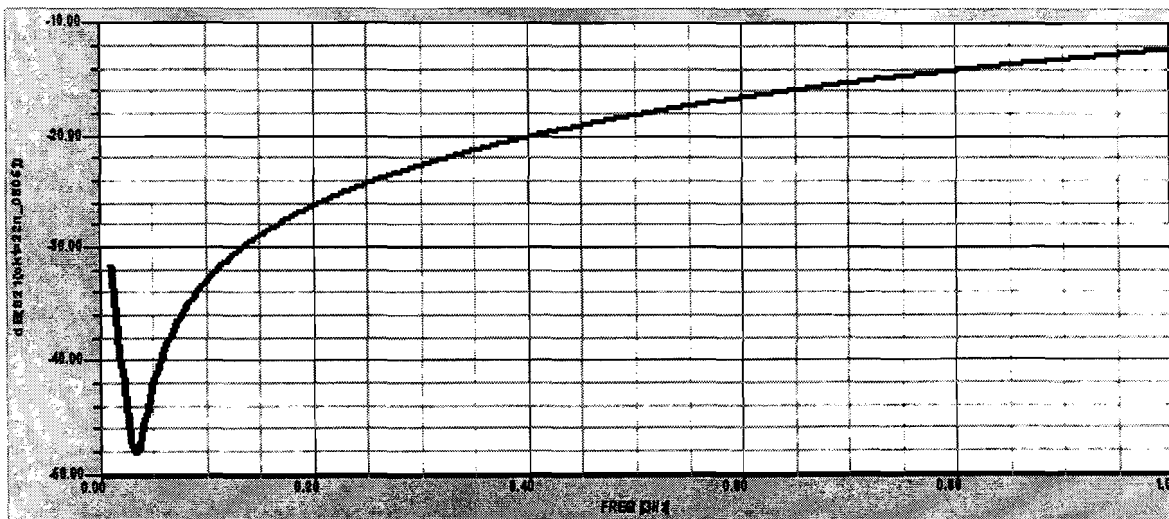

**Figure 21: 22nF X7R parallel capacitor filter (50R system)**

## 4.11 Double Sided boards

If using double sided printed circuit boards for RF work, try to keep one side as solid copper. This is actually quite simple when using surface mounting parts and the Kinsten PCB system. A paper on this was presented at Gippstech 2000.

Consider the use of thinner substrates. This allows the use of thinner tracks to get the same trace impedance. Double sided Kinsten PCB material is available down to thicknesses of 0.4mm thick. A 50 ohm trace on this substrate is only 0.74mm wide.

## 4.12 A small note on DC blocks

### 4.12.1 J0 coupling is not always best

Some broadband amplifiers can run into lower frequency stability problems if not properly terminated. For higher frequency operation the difference in insertion loss between using a J0 (series resonant) capacitor and a capacitor of much larger value is often fairly small. Also smaller value capacitors tend to have higher ESR which dominates the series loss compared to the parasitic inductance. A 100nF 0805 X7R surface mount capacitor, even though it has a series resonance at about 16MHz, can be quite useful for low loss coupling applications through to microwave frequencies because of its relatively low ESR. Even lower coupling loss can be made possible by paralleling capacitors of the same value.

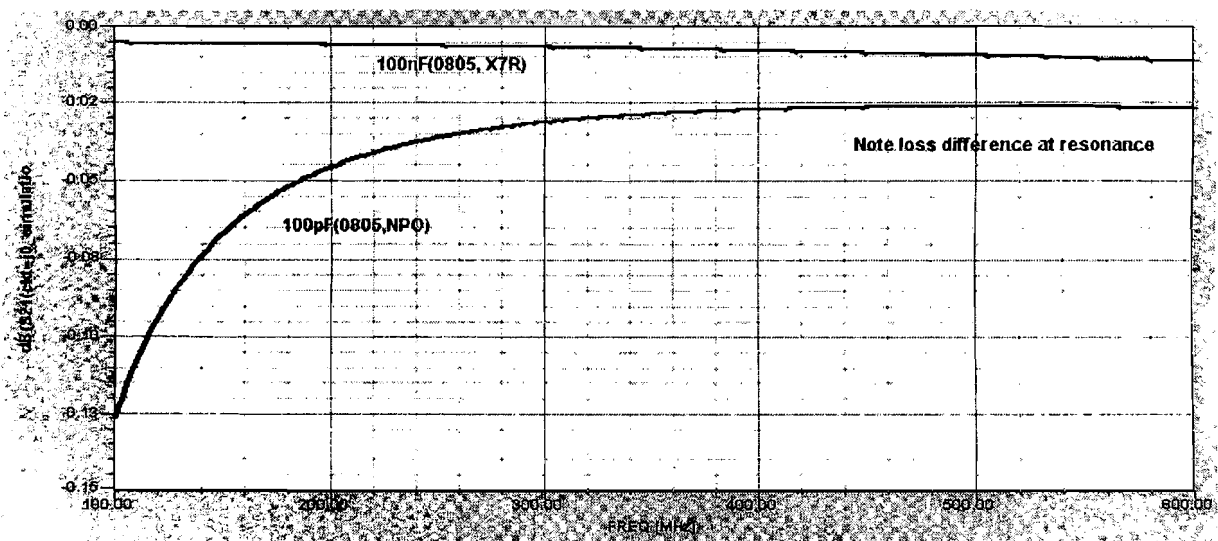
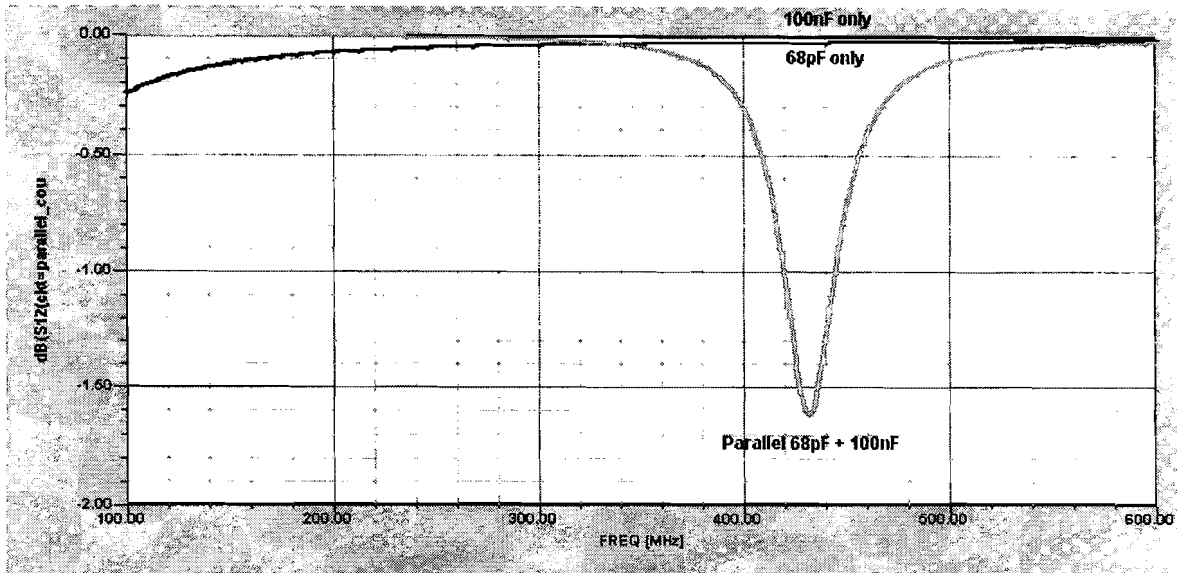

Figure 22: Comparison of 100n,X7R and 100pF, NPO capacitor insertion loss.

### 4.12.2 Beware of “broadbanding” by paralleling capacitors

Many people place two values of capacitors in parallel to so called “broadband” the coupling. This is a very bad practice. The reality is that it tends to create an impedance hole where the series inductance of the larger capacitor resonates with the capacitance of the smaller one. At best the impedance hole creates additional loss over just using either of the capacitor values on its own. At worst case it can lead to instability due to termination in an effectively parallel resonant circuit.



**Figure 23- Parallel Coupling Capacitors. Note impedance “hole” around 430MHz.**

### **5. EMC Testing:**

The proof of the pudding! The following pictures show antennas used at a NATA accredited open air test site (OATS). Commercial equipment is generally required to emit isotropic power at unwanted frequencies of less than 12 to 18 nanowatts (depending on the which standard applies) at frequencies below 1GHz.

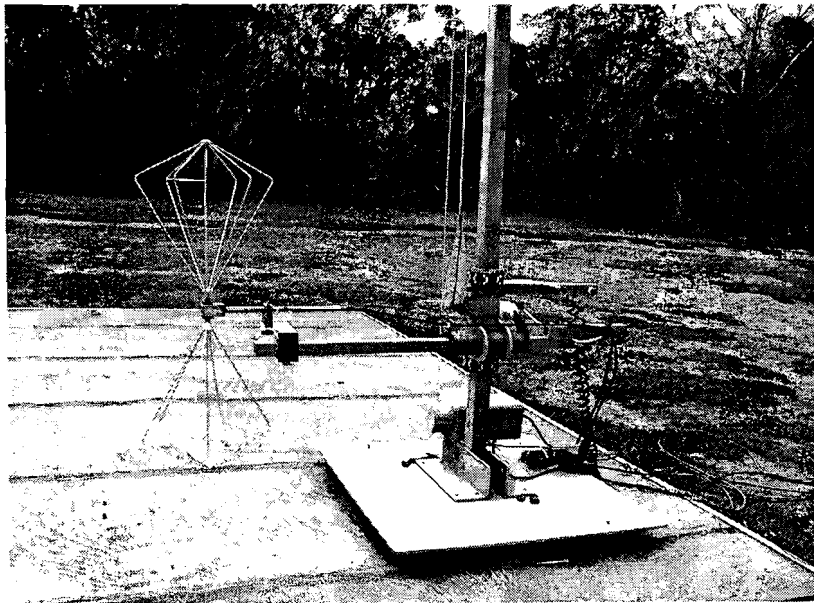

**Figure 24 – A broadband antenna used for testing to 230MHz.**

**Antenna height is remotely adjustable up to 4 metres.  
(Equipment courtesy of EMC Technologies Pty Ltd)**

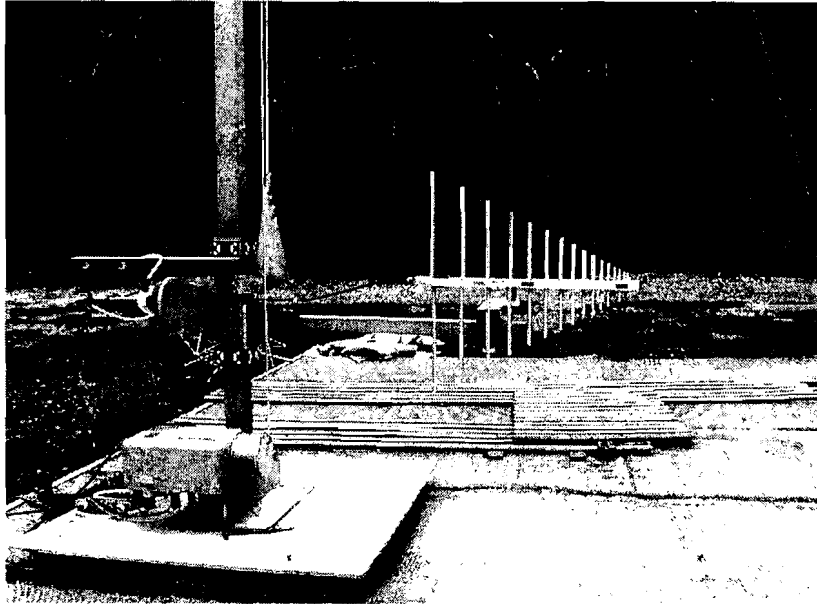

**Figure 25 – Log Periodic antenna used for testing 230MHz-1GHz  
(Equipment courtesy of EMC Technologies Pty Ltd)**

## **6. The final solution – A few rules for a good design**

- ALWAYS aim try to stop noise or susceptibility at its source.
- High edge rate (square wave carrying) traces should be very short in length or properly terminated.
- Filter slower I/O lines with appropriate RC or LC filtering.
- Consider adding shunt capacitors when using ferrite beads.
- Take significant care with ground reference points.
- If using shielding make sure it is complete, as small as possible and does not have any gaps.
- Avoid putting splits in ground or power planes unless you are AT LEAST 100% SURE what you are doing!
- NEVER run ANY signal carrying PCB traces across power and ground splits.
- Bypass all signals from connecting cables as close as possible to the equipment case earth next to the signal connector.
- Be very careful of parallel resonances if paralleling supply bypass or coupling capacitors of different values. If you have to do this always simulate it first!
- Do not rely on the equipment enclosure to contain RF emissions. The amount of radiation inside the case should be minimal to start with.
- Remember that current always flows in loops. (Its surprising how many people forget this!)
- If you are not sure how a circuit will work – Simulate it

- Try to avoid using “rules of thumb”. In many cases they are plain wrong unless they can be supported by proper analysis or test. They should never be used as a shortcut to proper engineering analysis. Just because the rule “always used to work” does not mean it still will. As many circuits make more use of higher RF frequencies more and more of these old “rules” are being proved invalid.

## **7. Conclusion**

Noise can be easily managed if its cause is understood. The key to successfully mixing RF and digital technology is by good analysis and design right from the outset.

A bit of effort in trying to understand how a problem could occur and the most efficient method of filtering or containment can save a lot of heartache trying to patch up a bad design.

A proper analysis of a problem to stop it right at its source will give much more rewarding results than covering cables with lots of ferrite clamps or trying to seal the gaps of a large metal box.

## **8. References:**

Simulations were done using Ansoft Serenade SV 8.5 <http://www.ansoft.com>

Design Techniques for EMC – a brilliant collection of articles on EMC and noise minimisation.  
<http://www.compliance-club.com/archive1/archindex.html>

Simulation Tools, Real components and Limitations. Presented at Gippstech 2001

[http://www.users.bigpond.net.au/vk3yng/sim\\_tools/simulation\\_tools1.htm](http://www.users.bigpond.net.au/vk3yng/sim_tools/simulation_tools1.htm)

Making Printed Circuits at Home. Presented at Gippstech 2000

[http://www.users.bigpond.net.au/vk3yng/pcb/making\\_pcb.htm](http://www.users.bigpond.net.au/vk3yng/pcb/making_pcb.htm)

Simulating Circuits and Systems with Serenade SV. By David Newkirk, W9VES, QST January 2001, pp37-43

High Speed PCB and System Design. By Lee W Ritchey, Speeding Edge, U.S.A.  
Presented at SMCBA Melbourne, April 1999.