



Level 3 Service Manual

Product Family B65

Tri-Band Digital Wireless Telephone



T720
GSM 850/1900 MHz & GPRS Technology

Contents

Introduction	5
Product Identification	5
Product Names	5
Product Changes	5
Regulatory Agency Compliance	5
Computer Program Copyrights	6
About this Service Manual	6
Warranty Service Policy	7
Parts Replacement	8
Specifications	9
Product Overview	11
Features	11
General Operation	15
Controls, Indicators, and Input/Output (I/O) Connections	15
User Interface Menu Structure	18
Alert Settings	18
Battery Function	19
Operation	19
Tools and Test Equipment	21
Disassembly	22
Removing and Replacing the Battery Housing and Battery	22
Removing and Replacing the Subscriber Identity Module (SIM)	24
Removing and Replacing the Antenna	25
Removing and Replacing the Rear Housing Assembly	25
Removing and Replacing the Transceiver Board Assembly	28
Removing and Replacing the Keypad	30
Removing and Replacing the Flip Cover	31
Removing the LED Light Guard	32
Removing and Replacing the Flip Assembly	33
Removing and Replacing the Display Module	36
Subscriber Identity Module (SIM) and Identification	37
SIM Card	37
Personality Transfer	37
Identification	37
Troubleshooting	39
Manual Test Mode	39
Manual Test Mode Commands	39
Troubleshooting Chart	41
Programming: Software Upgrade and Flexing	43
Part Number Charts	45
Related Publications	45
Exploded View Diagram	46
Exploded View Parts List	47
Accessories	48

Introduction

Motorola® Inc. maintains a worldwide organization that is dedicated to provide responsive, full-service customer support. Motorola products are serviced by an international network of company-operated product care centers as well as authorized independent service firms.

Available on a contract basis, Motorola Inc. offers comprehensive maintenance and installation programs that enable customers to meet requirements for reliable, continuous communications.

To learn more about the wide range of Motorola service programs, contact your local Motorola products representative or the nearest Customer Service Manager.

Product Identification

Motorola products are identified by the model number on the housing. Use the entire model number when inquiring about the product. Numbers are also assigned to chassis and kits. Use these numbers when requesting information or ordering replacement parts.

Product Names

Product names included in Product Family 0B65 (PF B65) telephones are listed on the front cover. Product names are subject to change without notice. Some product names, as well as some frequency bands, are available only in certain markets.

Product Changes

When electrical, mechanical or production changes are incorporated into Motorola products, a revision letter is assigned to the chassis or kit affected, for example; -A, -B, or -C.

The chassis or kit number, complete with revision number is imprinted during production. The revision letter is an integral part of the chassis or kit number and is also listed on schematic diagrams and printed circuit board layouts.

Regulatory Agency Compliance

This device complies with Part 15 of the FCC Rules. Operation is subject to the following conditions:

- This device may not cause any harmful interference, and
- must accept interference received, including interference that may cause undesired operation.

This class B device also complies with all requirements of the Canadian Interference-Causing Equipment Regulations (ICES-003).

Cet appareil numérique de la classe B respecte toutes les exigences du Règlement sur le matériel brouilleur du Canada.

Computer Program Copyrights

The Motorola products described in this manual may include Motorola computer programs stored in semiconductor memories or other media that are copyrighted with all rights reserved worldwide to Motorola. Laws in the United States and other countries preserve for Motorola, Inc. certain exclusive rights to the copyrighted computer programs, including the exclusive right to copy, reproduce, modify, decompile, disassemble, and reverse-engineer the Motorola computer programs in any manner or form without Motorola's prior written consent. Furthermore, the purchase of Motorola products shall not be deemed to grant either directly or by implication, estoppel, or otherwise, any license or rights under the copyrights, patents, or patent applications of Motorola, except for a nonexclusive license to use the Motorola product and the Motorola computer programs with the Motorola product.

About this Service Manual

Using this service manual and the suggestions contained in it assures proper installation, operation, and maintenance of PF B65 telephones. Refer questions about this manual to the nearest Customer Service Manager.

A product family is the group of products having the same account product code (APC). To locate the APC on a device, refer to "Mechanical Serial Number (MSN)" later in this manual.

Audience

This manual aids service personnel in testing and repairing PF B65 telephones. Service personnel should be familiar with electronic assembly, testing, and troubleshooting methods, and with the operation and use of associated test equipment.

Use of this manual assures proper installation, operation, and maintenance of Motorola products and equipment. It contains all service information required for the equipment described and is current as of the printing date.

Scope

The scope of this document is to provide the basic information relating to PF B65 telephones, and also to provide procedures and processes for repairing the units at Level 1 and 2 service centers including:

- Unit swap out
- Repairing of mechanical faults
- Basic modular troubleshooting
- Testing and verification of unit functionality
- Initiate warranty claims and send faulty modules to Level 3 or 4 repair centers

Conventions

Special characters and typefaces, listed and described below, are used in this manual to emphasize certain types of information.



Note: Emphasizes additional information pertinent to the subject matter.



Caution: Emphasizes information about actions that may result in equipment damage.



Warning: Emphasizes information about actions that may result in personal injury.



Keys to be pressed are represented graphically. For example, instead of “Press the Enter Key”, you will see “Press ”.

Information from a screen is shown in text as similar as possible to what appears in the display. For example, **ALERTS** or `ALERTS` or `ALERTS`.

Information that you need to type is printed in **boldface type**

Revisions

Any changes that occur after manuals are printed are described in publication revision bulletins (PMRs). These bulletins provide change information that can include new parts listing data, schematic diagrams, and printed circuit board layouts.

Warranty Service Policy

The product is sold with the standard 12-month warranty terms and conditions. Accidental damage, misuse, and extended warranties offered by retailers are not supported under warranty. Non warranty repairs are available at agreed fixed repair prices.

Out of Box Failure Policy

The standard out of box failure criteria applies. Customer units that fail very early on after the date of sale, are to be returned to Manufacturing for root cause analysis, to guard against epidemic criteria. Manufacturing will bear the costs of early life failure.

Product Support

Customer's original unit will be repaired but not refurbished as standard. Appointed Motorola Service Hubs will perform warranty and non-warranty field service for level 2 (assemblies) and level 3 (limited PCB component). The Motorola HTC centers will perform level 4 (full component) repairs.

Customer Support

Customer support is available through dedicated Call Centers and in-country help desks. Product Service training should be arranged through the local Motorola Support Center.

Parts Replacement

When ordering replacement parts or equipment, include the Motorola part number and description used in the service manual or supplement.

When ordering crystals or channel elements, specify the Motorola part number, description, crystal frequency, and operating frequency desired.

When the Motorola part number of a component is not known, use the product model number or other related major assembly along with a description of the related major assembly and of the component in question.

In the U.S.A., to contact Motorola, Inc. on your TTY, call: 800-793-7834.

Accessories and Aftermarket Division (AAD)

Replacement parts, test equipment, and manuals can be ordered from AAD.

U.S.A.

Phone: 800-422-4210

FAX: 800-622-6210

Outside U.S.A.

Phone: 847-538-8023

FAX: 847-576-3023

For spare parts in the EMEA region call +44 131 479 1274.

For spare parts in the Asia region call +65 648 62995.

Specifications

General Function	Specification
Frequency Range GSM	880-915 MHz Tx (with EGSM) 925-960 MHz Rx
Frequency Range DCS	1710-1785 MHz Tx 1805-1880 MHz Rx
Channel Spacing	200 kHz
Channels	174 EGSM, 374 DCS carriers with 8 channels per carrier
Modulation	GMSK at BT = 0.3
Transmitter Phase Accuracy	5 Degrees RMS, 20 Degrees peak
Duplex Spacing	45 MHz GSM, 95 MHz DCS
Frequency Stability	± 0.10 ppm of the downlink frequency (Rx)
Operating Voltage	+3.0V dc to +4.2V dc (battery) +4.4V dc to +6.3V dc (external connector)
Average Transmit Current	310 mA nominal at room temperature
Average Stand-by Current	6.4 mA (DRX2), 3.5 mA (DXR9) nominal at room temperature
Dimensions, with 550 mAh battery	90.47 mm x 47.3 mm x 23.3 mm (with CLI included) 90.47 mm x 47.3 mm x 21.3 mm (without CLI)
Size (Volume)	80.67 cc with 550 mAh battery 86.19 cc with 750 mAh battery 93.04 cc with 1100 mAh battery
Weight	106 gm with 550 mAh battery 111 gm with 750 mAh battery 122 gm with 1100 mAh battery
Temperature Range	-10° C to +55° C (+15° F to +130° F)
Battery Life, 550 mAh LI Ion Battery	Talk Time up to 220 minutes Standby up to 152 hours All talk and standby times are approximate and depend on network configuration, signal strength, and features selected. Standby times are quoted as a range from DRX=2 to DRX=9. Talk times are quoted as a range from DTX off to DTX on.

Transmitter Function	Specification
RF Power Output	33 dBm nominal GSM, 30 dBm nominal DCS
Output Impedance	50 ohms nominal
Spurious Emissions	-36 dBm from 0.1 to 1 GHz, -30 dBm from 1 to 4 GHz

Receiver Function	Specification
Receive Sensitivity	-106 dBm GSM, -104 dBm DCS
RX bit error rate (100k bits) Type II	< 2%
Channel Hop Time	500 microseconds
Time to Camp	Approximately 5-10 seconds

Speech Coding Function	Specification
Speech Coding Types	FR - Regular pulse excitation / linear predictive coding with long term prediction (RPE LPC with LTP) HR - Vector sum excited linear prediction (VSELP) EFR - Algebraic CELP (ACELP) AMR - Algebraic CELP (ACELP)

Speech Coding Function	Specification
Bit Rate	13.0 kbps (FR) 12.2 kbps (EFR) 4.75 - 12.2 kbps (8 AMR TCH/FS modes) 5.6 kbps (HR) 4.75 - 7.95 kbps (6 AMR TCH/HS modes)
Frame Duration	20 ms
Block Length	260 bits
Classes	Class 1 bits = 182 bits; Class 2 bits = 78 bits
Bit Rate with FEC Encoding	22.8 kbps

Product Overview

Motorola PF B65 telephones feature global system for mobile communications (GSM) air interface, general packet radio service (GPRS) transport technology, and wireless application protocol (WAP) Internet. The PF B65 incorporates a color user interface (UI) that is both icon and list-based for easy operation, allows Short Message Service (SMS) text messaging, and includes personal information manager (PIM) functionality. The PF B65 is a dual-band phone that allows roaming within the GSM 900 MHz and digital cellular system (DCS)1800 MHz bands.

PF B65 telephones support GPRS and SMS in addition to traditional circuit switched transport technologies. GPRS, where available, provides substantial increases in mobile data communications performance and the efficient use of radio spectrum. Data transmission rates for GSM networks can potentially increase from the current rate of 9.6 kbps up to a theoretical maximum of 171.2 kbps. An increased data rate is by no means the only benefit provided by GPRS. A key advantage is the provision of a permanent virtual connection to the network. This “always on” connection is possible because GPRS uses packet data transfer so that, for example, email can be downloaded in “background mode.” There is no need for the user to reconnect before requesting a service, eliminating connection set-up delays and adding convenience and immediacy to data services access. The “virtual” nature of this connection means that network resources are not consumed during periods when a user is not actually sending or receiving data.

The telephones are made of polycarbonate plastic with a metal enclosure. The display and speaker, as well as the keypad, transceiver printed-circuit board (PCB), microphone, charger and headphone connectors, and power button are contained within the clam form-factor housing. The standard 550 mAh Lithium Ion (Li Ion) battery fits behind the back cover.

The phone accepts 3V mini subscriber identity module (SIM) cards which fit into the SIM holder underneath the battery. The antenna is a fixed stub type antenna. Inexpensive direct connection to a computer or handheld device via RS232 or USB for data and fax calls, and for synchronizing phonebook entries with TrueSync® software, can be accomplished by using the optional data cable and soft modem.

Features

PF B65 telephones use advanced, self-contained, sealed, custom integrated circuits to perform the complex functions required for GSM GPRS communication. Aside from the space and weight advantage, microcircuits enhance reliability, simplify maintenance, and provide a wide variety of operational functions.

Features available in this family of telephones include:

- Low voltage technology that provides increased standby and talk times
- Extended GSM (EGSM) channels
- Tri-coder/decoder (CODEC) that allows full rate, half rate, and enhanced full rate modes of transmission
- Supports mobile originated/mobile terminated SMS, concatenated SMS, and cell broadcast messages¹
- Supports GPRS, circuit switched, and SMS networks¹
- WAP 1.1 compliant¹

1. Network, subscription and SIM card or service provider dependent feature. Not available in all areas.

- Supports SIM Toolkit (STK), Class 2¹
- Caller ID with link to phone book alerts¹
- Dual tinted mirror film (TMF) displays with electroluminescent (EL) backlighting: internal 96 x 64 pixel; external 96 x 16 pixel.
- Internal display provides 3 lines of text, 1 line of icons, and 1 line of prompts.
- Display zoom
- Display animation
- PIM functionality includes: date book, message center, and 400 number phone book with Starfish® and TrueSync® support¹
- Voice activation for phonebook entries and menu shortcuts
- Voice note voice recorder²
- iTAP™ software for predictive text entry
- Turbo Dial® abbreviated dialing.
- Multi-language support
- 32 alerts
- VibraCall® vibrating alert
- Data capable without PC card using RS232 or USB
- Integrated headset jack
- Smart button operation
- Hearing aid telephone interconnection system (HATIS) support³

Speaker Dependant Voice Activation and Voice Note Recording

This feature allows voice tags to be used for voice dialing up to 20 phone numbers in the phone book and for creating up to 5 voice shortcuts for menu items. The phone must be “trained” by the voice tag being read into the phone’s memory twice before it is recognized.

Voice tags can be added to the phone’s memory using the usual name addition methods (i.e., via the phone book menu structure or with the shortcut editor).



The user cannot place or receive calls while adding voice tags to the phone’s memory.



Because the GSM standard does not provide the option to store voice tags onto the SIM card, voice tags are added to the phone’s memory.

1. Designed to synchronize with basic features of the initial release of many popular Personal Information Management (PIM) software and hardware products.

2. Use of this function may be subject to varying State and Federal laws regarding privacy of phone conversations.

3. Not compatible with all hearing aids. Hearing aids must contain a T-coil. T-coil must be activated when using the phone.

PF B65 telephones also include a voice note recorder that allows up to 2 minutes of personal messages to be recorded. This feature has a complete set of record, playback, and management tools that make it easy to store and maintain a list of personal memos.

Wireless Access Protocol (WAP) 1.1 Compliancy

In the WAP environment, access to the Internet is initiated in wireless markup language (WML), which is derived from hypertext markup language (HTML). The request is passed to a WAP gateway which retrieves the information from the server in standard HTML (subsequently filtered to WML) or directly in WML if available. The information is then passed to the mobile subscriber via the mobile network.

The PF B65's microbrowser can be configured for baud, idle timeout, line type, phone number, and connection type.



Bitmap image data will download as text. If the image is larger than the screen, only part of the image will display.



When the user receives a call while in browser mode, the browser will pause and allow the user to resume after completing the call.

SIM Application Toolkit™ - Class 2

SIM Application Toolkit is a value-added service delivery mechanism that allows GSM operators to customize the services they offer their customers, from the occasional user who requests sports news and traffic alerts, to a high call time business user who receives stock alerts and checks flight times. Operators can now create their own value-added services menu quickly and easily in the phone. The customized menu will appear as the first menu and may be updated over-the-air with new services when customers request them.

Simplified Text Entry

Using iTAP™ predictive text entry, pressing a key generates a character, and a dynamic dictionary uses this to build and display a set of word or name options. The iTAP™ feature may not be available in all languages.

Caller Line Identification

Upon receipt of a call, the calling party's phone number is compared to the phone book. If the number matches a phone book entry, that name displays. If there is no phone book entry, the incoming phone number displays. If no caller identification information is available, the Incoming Call message displays.



User must subscribe to a caller line identification service through their service provider.

Other Features

Detailed descriptions of these and the other PF B65 features can be found in the appropriate PF B65 telephone user guide listed in the “Related Publications” section toward the end of this manual.

General Operation

Controls, Indicators, and Input/Output (I/O) Connections

The PF B65 telephone's controls are located on the sides of the device and on the keypad (see Figure 1). Indicators, in the form of icons, are displayed on the LCD (see Figure 2). Service status is indicated by a tri-color light emitting diode (LED) located at the top of the phone on the right knuckle (Table 1). PF B65 phones have an audible alert transducer on the top and I/O connectors, consisting of a headset jack and an accessory port, located on the top and bottom of the phone.



Figure 1. PF B65 Phone Controls, Indicators and I/O

Service Indicator

The service indicator (status light) changes color to show the user the state of the phone as shown in Table 1, below.

Table 1. Service Indicator States

Indication	State
Alternating red / green	Incoming call
Flashing green	In service, home system
Flashing yellow	Roaming, non-home system
Flashing red	No service

Liquid Crystal Display (LCD)

The LCD provides a high contrast backlit display for easy readability in all light conditions. The large bit-mapped 96 x 64 display includes 3 lines of text, 1 line of icons, and 1 line of prompts.

Display zoom allows setting the phone's display to show either three lines or two lines of text plus soft key labels. Three lines of text display more information, while two lines increase text size for improved visibility.

Display animation makes the phone's menus move smoothly as the user scrolls up and down. Turn animation off to conserve the battery.

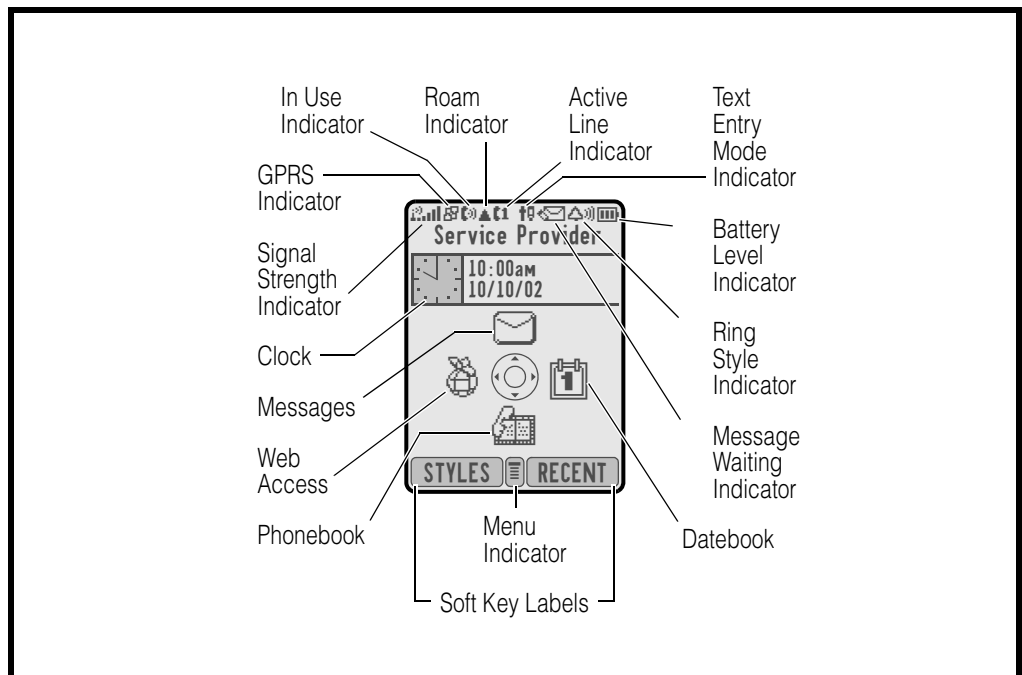







Figure 2. PF B65 Icon Indicators



Whether a phone displays all indicators depends on the programming and services to which the user subscribes.

Figure 2 shows common icons displayed on the LCD.

- **Signal Strength Indicator.** Shows the strength of the phone's connection with the network. Calls cannot be sent or received when the "no signal" indicator is displayed.
- **GPRS Indicator.** Your service provider may use this indicator to indicate that a GPRS packet data connection is active. This type of connection may be used by your service provider to allow faster data transfer speeds. The GPRS indicator does not mean you are in a call; it indicates only that you are registered on the network via a GPRS connection.
- **In Use Indicator.** Appears when a call is in progress.
- **Roam Indicator.**⁵ Appears when the phone uses another network system outside the user's home network. When leaving the home network area, the phone roams, or seeks another network.
- **Message Waiting Indicator.**⁵ Appears when the phone receives a text message. This is a network-dependent feature.
- **Voice Message Waiting Indicator.**¹ Appears when a voicemail message is received. This is a network-dependent feature.
- **Battery Level Indicator.** Shows the amount of charge left in the battery. The more segments visible, the greater the charge. Recharge the battery as soon as possible when the Low Battery warning message appears.
- **Active Line.** When you use a SIM card that supports dual phone lines, this indicator shows the current active phone line.
- **Ring Style.** Shows the current selected alert style. The default setting is a loud ring.
 -  = loud ring
 -  = soft ring
 -  = vibrate
 -  = ring and vibrate
 -  = silent
- **Menu Indicator.** Indicates the user can press the menu soft key to open a menu.

1. Network, subscription and SIM card or service provider dependent feature. Not available in all areas.

User Interface Menu Structure

Figure 3 shows the PF B65 telephone menu structure.

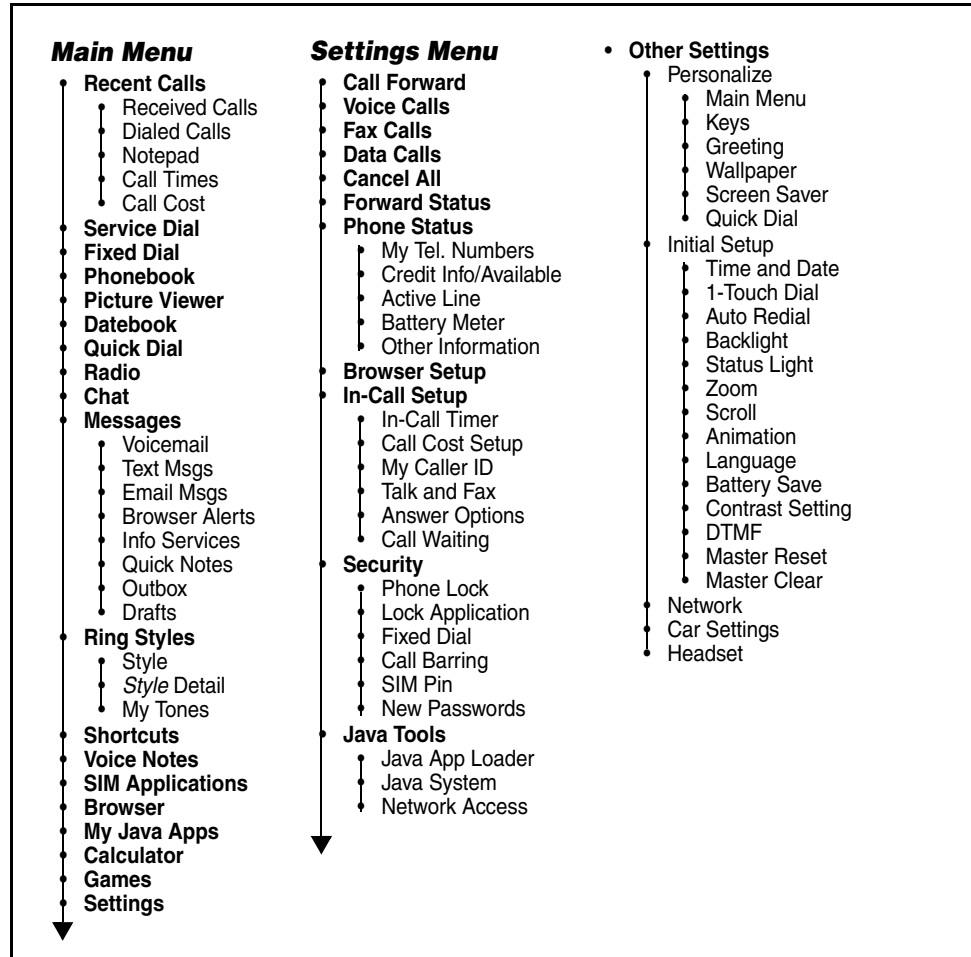

Figure 3. PF B65 Menu Structure

Alert Settings

PF B65 telephones include up to 32 preset alert tones and vibrations that can be applied to all alert events at the same time.



Pressing either volume key mutes the alert.

Battery Function

Battery Gauge

The telephone displays a battery level indicator icon in the idle screen to indicate the battery charge level. The gauge shows four levels: 100%, 66%, 33%, and Low Battery.

Battery Removal

Removing the battery causes the device to immediately shut down and any pending work (for example, partially entered phone book entries or outgoing messages) is lost.



To ensure proper memory retention, turn OFF the phone before removing the battery. Immediately replace the old battery with a fresh battery.



If the battery is removed while receiving a message, the message will be lost.

Operation

For detailed operating instructions, refer to the appropriate user's guide listed in the Related Publications section toward the end of this manual.

Tools and Test Equipment

The following table lists tools and test equipment recommended for disassembly and reassembly of PF B65 telephones. Use either the listed items or equivalents.

Table 2. General Test Equipment and Tools

Motorola Part Number ¹	Description	Application
RSX4043-A	Torque Driver	Used to remove and replace screws
—	Torque Driver Bit T-6 Plus, Apex 440-6IP Torx Plus or equivalent	Used with torque driver
See Table 7	Rapid Charger	Used to charge battery and power phone
0180386A82	Antistatic Mat Kit (includes 66-80387A95 antistatic mat, 66-80334B36 ground cord, and 42-80385A59 wrist band)	Provides protection from damage to device caused by electrostatic discharge (ESD)
6680388B67	Disassembly tool, plastic with flat and pointed ends (manual opening tool)	Used during assembly/disassembly of phone
6680388B01	Tweezers, plastic	Used during assembly/disassembly
—	Digital Multimeter, HP34401A ²	Used to measure battery voltage
8102430Z04	GSM / DCS Test SIM	Used to enable manual test mode

1. To order in North America, contact Motorola Aftermarket and Accessories Division (AAD) at (800) 422-4210 or FAX (800) 622-6210; Internationally, AAD can be reached by calling (847) 538-8023 or by fax (847) 576-3023.

2. Not available from Motorola. To order, contact Hewlett Packard at (800) 452-4844.

Disassembly

The procedures in this section provide instructions for the disassembly of a PF B65 telephone. Tools and equipment used for the phone are listed in Table 2, preceding.



Many of the integrated devices used in this phone are vulnerable to damage from electrostatic discharge (ESD). Ensure adequate static protection is in place when handling, shipping, and servicing the internal components of this equipment.



Avoid stressing the plastic in any way to avoid damage to either the plastic or internal components.

Removing and Replacing the Battery Housing and Battery



All batteries can cause property damage and/or bodily injury such as burns if a conductive material such as jewelry, keys, or beaded chains touch exposed terminals. The conductive material may complete an electrical circuit (short circuit) and become quite hot. Exercise care in handling any charged battery, particularly when placing it inside a pocket, purse, or other container with metal objects.

1. Ensure the phone is turned off.
2. Press in and hold the battery housing latch as shown in Figure 4.

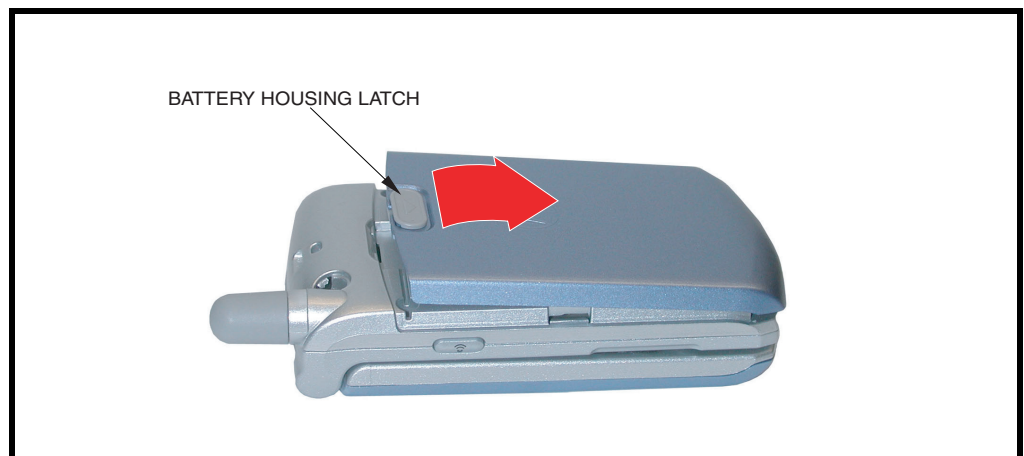

020200c

Figure 4. Removing the Battery Housing

3. Lift the battery housing completely off the phone.

4. Lift the end of the battery and remove it completely (See Figure 5).

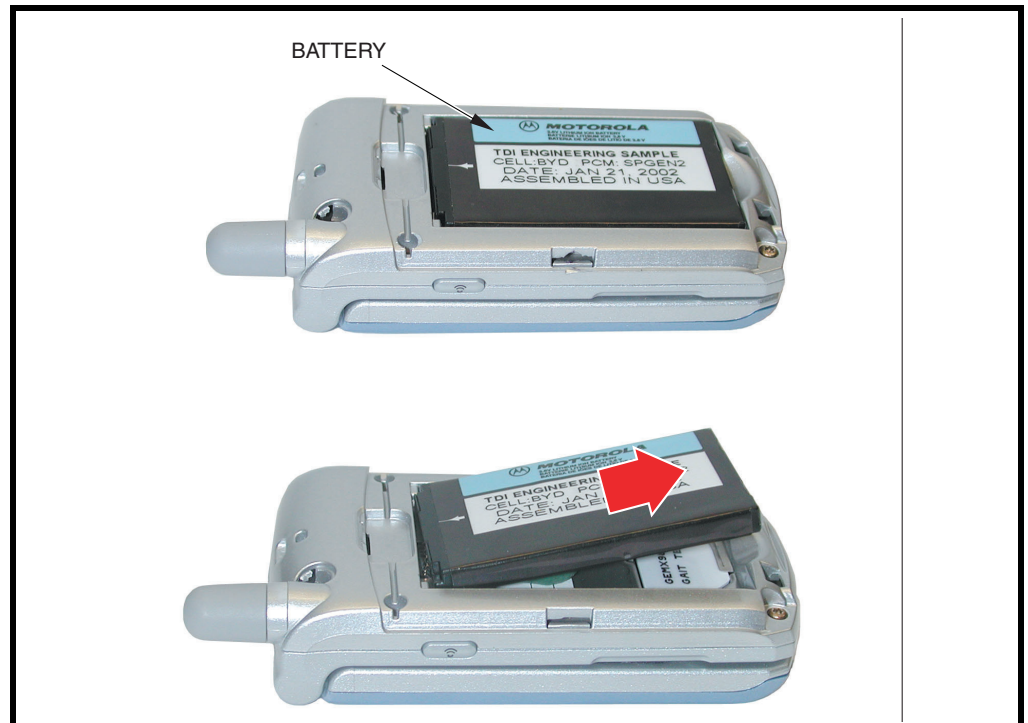

0202010

Figure 5. Removing the Battery



There is a danger of explosion if the Lithium Ion battery is replaced incorrectly. Replace only with the same type of battery or equivalent as recommended by the battery manufacturer. Dispose of used batteries according to the manufacturer's instructions.

5. To replace, align the battery with the battery compartment so the contacts on the battery match the battery contacts in the phone.
6. Insert the battery, printed arrow first, into the battery compartment and push down.
7. Insert the ridge at the bottom of the battery housing into the base of the phone, then push the cover down and snap it into place.

Removing and Replacing the Subscriber Identity Module (SIM)

1. Remove the battery housing and battery as described in the procedures.
2. Slide the SIM lock away from the SIM card to unlock as shown in Figure 6.
3. Carefully lift the SIM from its holder.

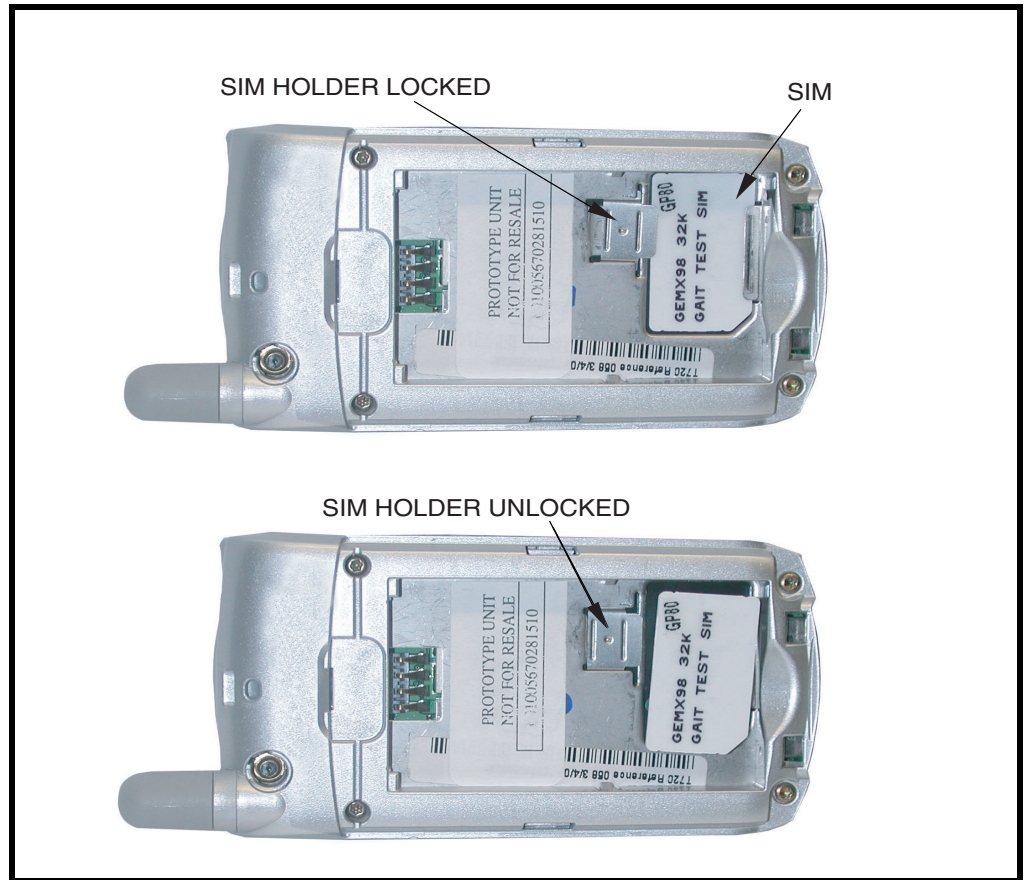

020202o

Figure 6. Removing the SIM

4. To replace, insert the SIM into the holder, ensuring the keyed corner of the SIM aligns with the notch molded into the holder.
5. Lock the SIM into place by sliding the lock towards the SIM card.
6. Replace the battery and battery housing as described in the procedures.

Removing and Replacing the Antenna

1. Remove the battery housing and battery as described in the procedures.
2. By hand, rotate the antenna counterclockwise until loose. See Figure 7.

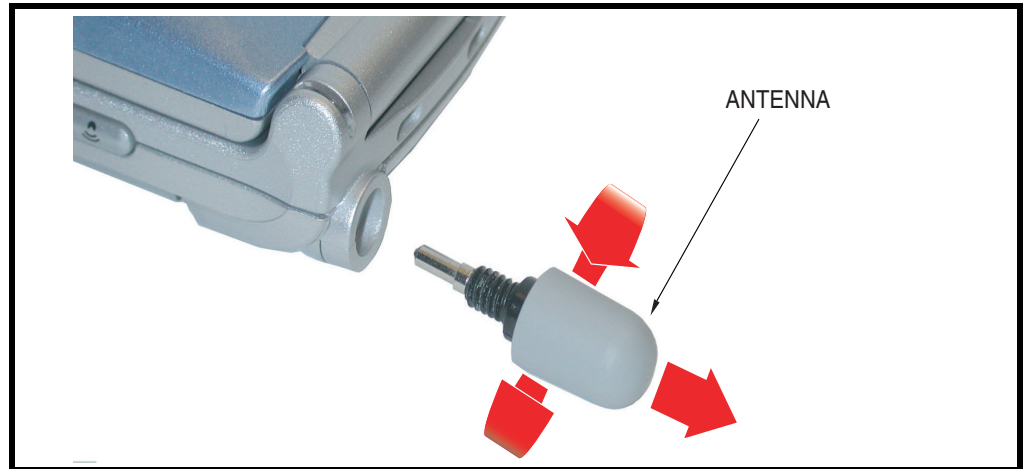

0202030

Figure 7. Removing the Antenna

3. When the antenna threads are completely disengaged, pull the antenna straight out of the phone to remove.



Ensure antenna threads are properly engaged before tightening to prevent damage to the antenna or housing.

4. To replace, insert the threaded end of the antenna carefully into the housing and, after ensuring the threads are properly engaged, rotate clockwise. Tighten firmly by hand.
5. Replace the battery and battery housing as described in the procedures.

Removing and Replacing the Rear Housing Assembly



This product contains static-sensitive devices. Use anti-static handling procedures to prevent electrostatic discharge (ESD) and component damage.

1. Remove the battery housing, battery, and antenna as described in the procedures.

5. Rotate the rear housing assembly and pull it away from the front housing to remove.



020204o

Figure 9. Removing the rear housing assembly

6. To replace, carefully align rear housing assembly with the front housing, then press the rear assembly down until the 2 housing catches engage with the corresponding openings on the rear housing. Press the housings together until the catches snap into place.
7. Replace the 4 screws and tighten securely. Do not over tighten.
8. Replace the antenna, battery, and battery housing as described in the procedures.

Removing and Replacing the Transceiver Board Assembly



This product contains static-sensitive devices. Use anti-static handling procedures to prevent electrostatic discharge (ESD) and component damage.

1. Remove the battery housing, battery, antenna, and rear housing assembly as described in the procedures.



The flexible printed cable (FPC) (flex) is easily damaged. Exercise extreme care when handling.

2. Using the plastic tweezers, remove the metal chassis shield (See Figure 10).

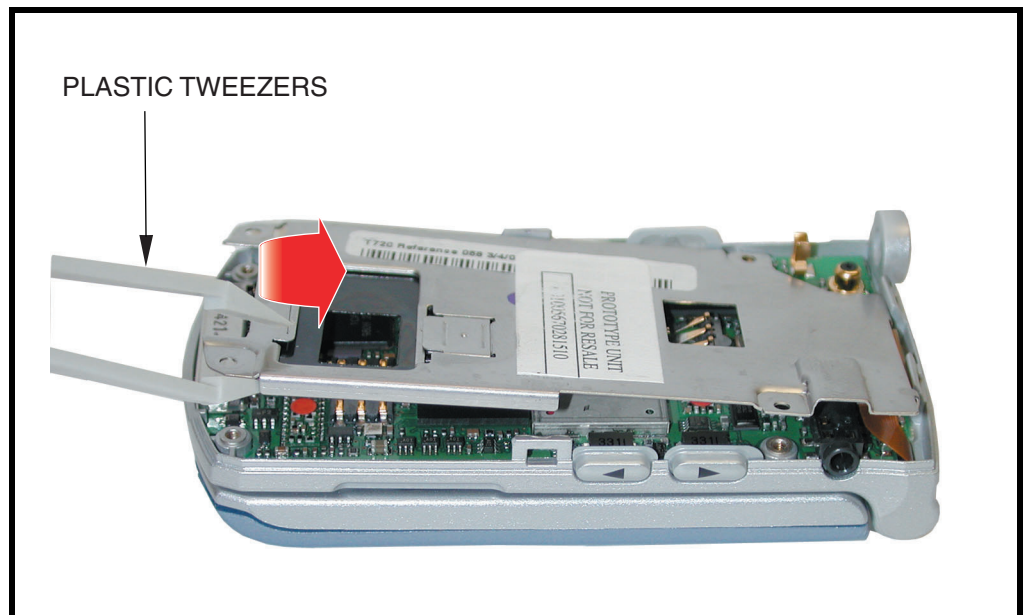

020252o

Figure 10. Removing the Chassis Shield

3. Carefully work the flat end of the disassembly tool under the flex connector and disconnect it from the transceiver board (See Figure 11).

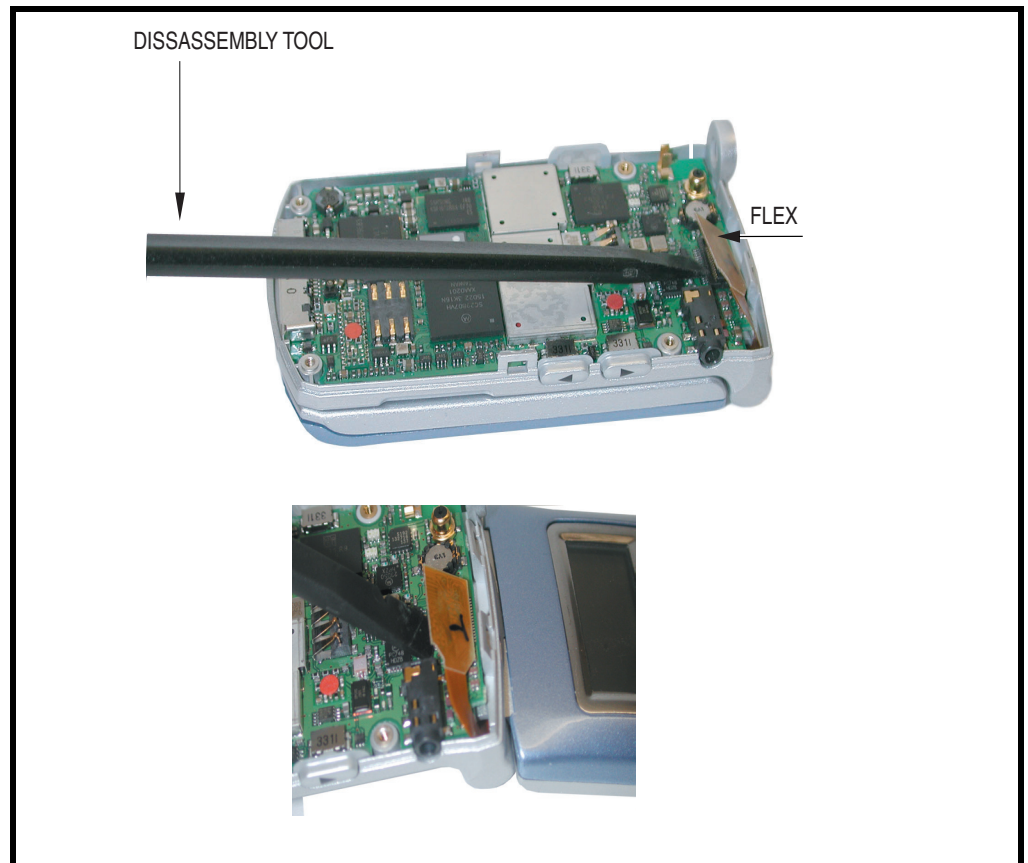

0202050

Figure 11. Disconnecting the Flex From the Transceiver Board

4. Using the disassembly tool, lift the transceiver board assembly from the front housing. To replace, insert the transceiver board assembly into the front housing with the flex connector on top.
5. Insert the flex connector squarely into its mating connector on the transceiver board and press firmly until it snaps into place.
6. Replace the metal chassis shield, rear housing assembly, antenna, battery, and battery housing as described in the procedures.

Removing and Replacing the Keypad

1. Remove the battery housing, battery, antenna, rear housing assembly, and transceiver board assembly as described in the procedures.
2. Lift the keypad from the front housing as shown in Figure 12.

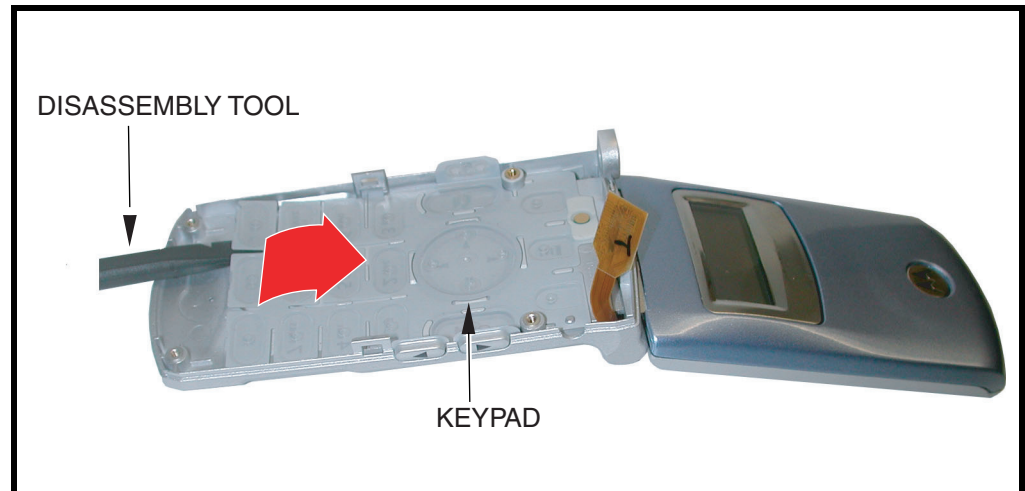

020207o

Figure 12. Removing the Keypad

3. To replace, insert the keypad into the front housing, ensuring the keys align properly with the openings in the front housing.
4. Replace the transceiver board, metal chassis shield, rear housing assembly, antenna, battery, and battery housing as described in the procedures.

Removing and Replacing the Flip Cover

1. Remove the battery housing, battery, antenna, rear housing assembly, transceiver board assembly, and keypad as described in the procedures.
2. Using the disassembly tool, lift the bottom end of the flip cover away from the flip assembly as shown in Figure 13.

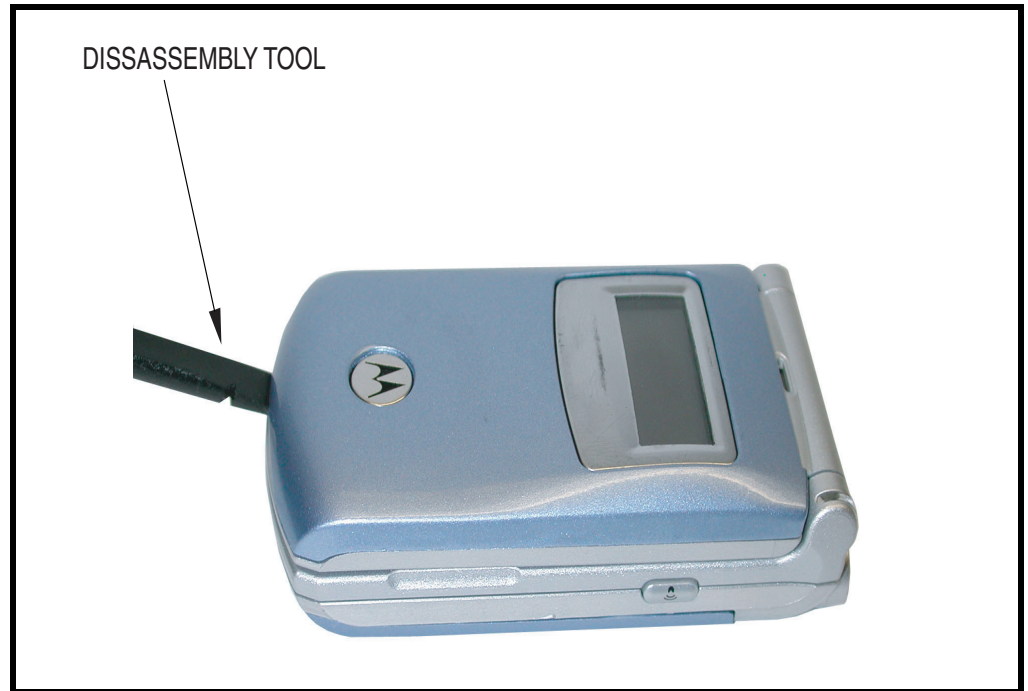

020253o

Figure 13. Removing the Flip Cover

3. To replace, align the top corners of the flip cover with the opening of the flip barrel and push down on all 4 corners of the cover until it snaps into place.
4. Replace the transceiver board, metal chassis shield, rear housing assembly, antenna, battery, and battery housing as described in the procedures.

Removing the LED Light Guard

1. Using the pointed end of the disassembly tool, push the clear plastic LED light guard out of the front housing from the inside of the housing (See Figure 14).



0202610

Figure 14. Removing the LED Light Guard

2. To replace, insert the LED light guard into the front housing from the front of the housing assembly, with the curved side of the guard facing the inside of the phone.
3. Replace the keypad, transceiver board, metal chassis shield, rear housing assembly, antenna, battery, and battery housing as described in the procedures.

Removing and Replacing the Flip Assembly

1. Remove the battery housing, battery, antenna, rear housing assembly, metal sheath, transceiver board, keypad, and flip cover as described in the procedures.



The flex is fragile and easily damaged. Be very careful when passing the flex through the front housing opening.

2. Seat the flip in the flip hinge disassembly fixture as shown in Figure 15. Gently push down on the flip hinge to ensure the flip is seated securely in the fixture, being careful to not damage the flex connector.
3. Close the flip and push the lever on the fixture down until it can go no further.
4. Open the flip and rotate it counterclockwise until the hinge disconnects from the barrel, exposing the hinge assembly (See Figure 15).

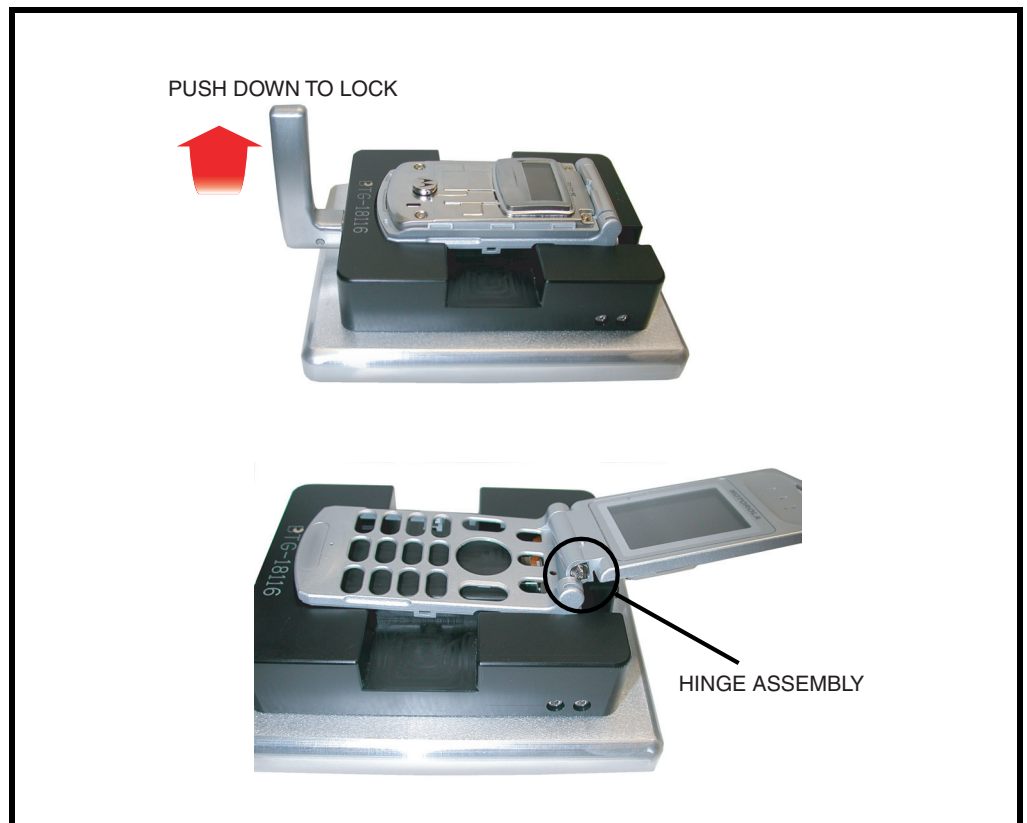

020258o

Figure 15. Removing the Flip Assembly From the Front Housing

5. Lift the lever on the fixture and remove the display module and front housing, being careful to not lose the hinge assembly screw or damage the flex connector.

6. To detach the flex connector, rotate the display module and carefully thread the flex connector through the opening in the base front housing (See Figure 16).

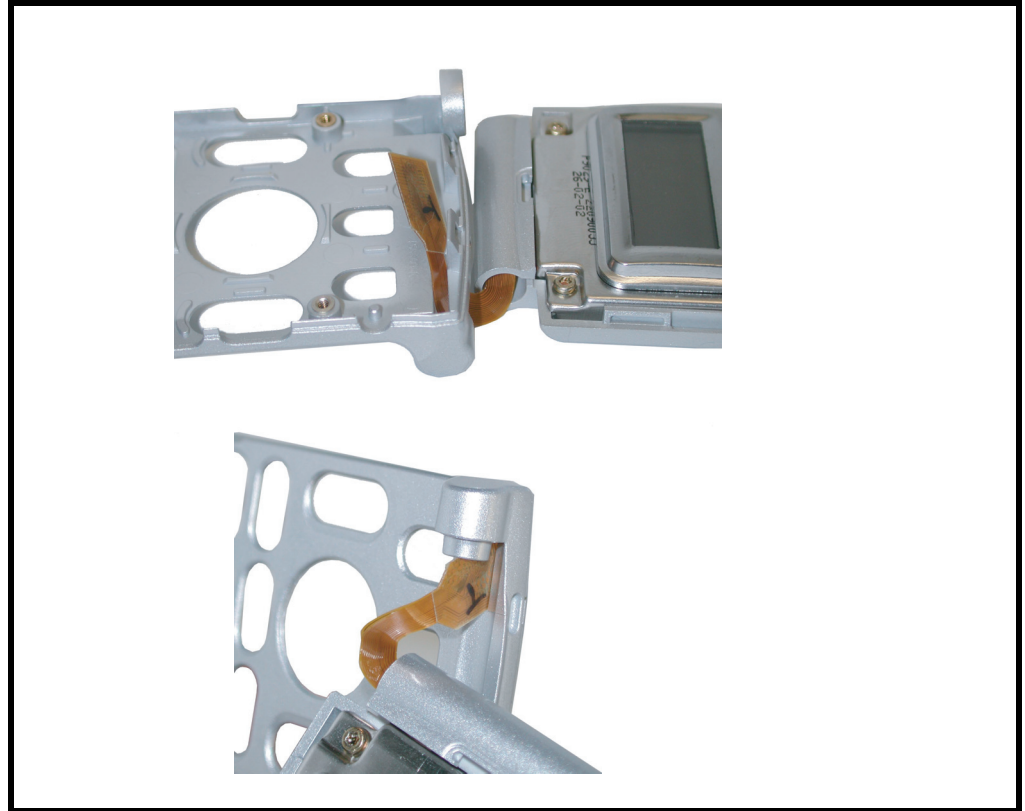

020259o

Figure 16. Removing the Flex Connector

7. To replace, thread the flex connector through the front housing opening at an angle.

8. Close the barrel of the flip on the side where the flex connector is located, leaving open the side where the hinge assembly will be inserted into the barrel (See Figure 17).

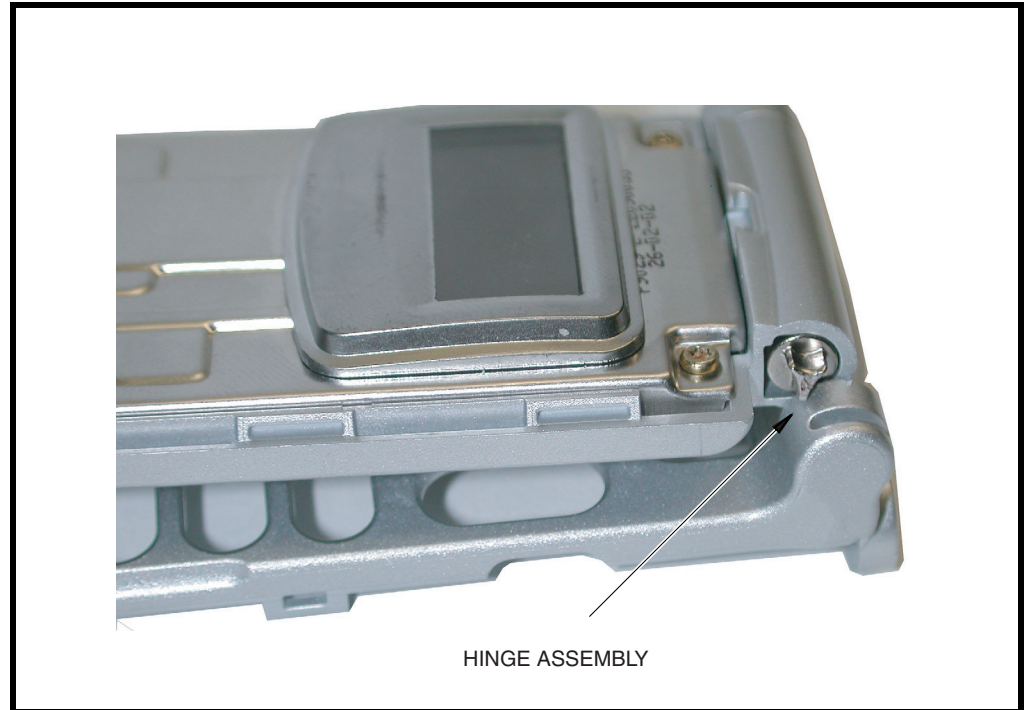

020262o

Figure 17. Replacing the Hinge Assembly

9. Insert the hinge assembly into the barrel. Use the flat end of the disassembly tool to push the hinge assembly into the barrel until it is flat. Rotate the hinge of the flip assembly into the front housing until they snap together.
10. Replace the keypad, keyboard assembly, spacer gasket, transceiver board assembly, rear chassis assembly, antenna, battery, and battery housing as described in the procedures.

Removing and Replacing the Display Module

1. Using a Torx driver with a T-6 bit, remove the 4 screws from the display module (See Figure 18).

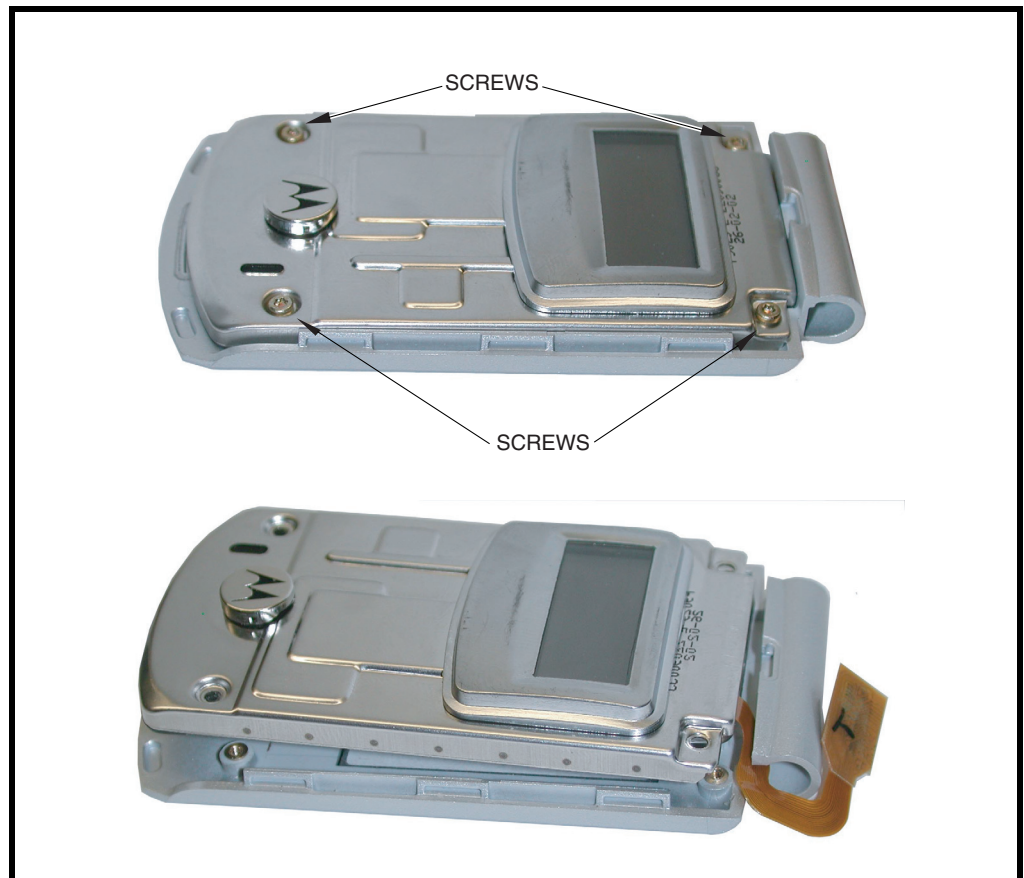

020263

Figure 18. Removing the Display Module

2. Lift the display module up and slide it out of its housing, being careful to not damage or stress the flex connector.
3. To replace, thread the flex connector into the housing barrel and seat the display module back into the flip front housing.
4. Replace the 4 display module screws.
5. Replace the keypad, keyboard assembly, spacer gasket, transceiver board assembly, rear chassis assembly, antenna, battery, and battery housing as described in the procedures.

Subscriber Identity Module (SIM) and Identification

SIM Card

A SIM is required to access the existing local GSM network, or remote networks when traveling (if a roaming agreement has been made with the provider).

The SIM contains:

- All the data necessary to access GSM services.
- The ability to store user information such as phone numbers.
- All information required by the network provider to provide access to the network.

Personality Transfer

A personality transfer is required when a phone is express exchanged or when the main board is replaced. Personality transfers reproduce the customer's original personalized details such as menu and stored memory such as phone books, or even just program a unit with basic user information such as language selection. PF B65 telephones use TrueSync® synchronization software to effect a personality transfer.

Identification

Each Motorola GSM device is labeled with a variety of identifying numbers. The following information describes the current identifying labels.

Mechanical Serial Number (MSN)

The Mechanical Serial Number (MSN) is an individual unit identity number and remains with the unit throughout the life of the unit.

The MSN can be used to log and track a unit on Motorola's Service Center Database.

The MSN is divided into 4 sections as shown in Figure 19.

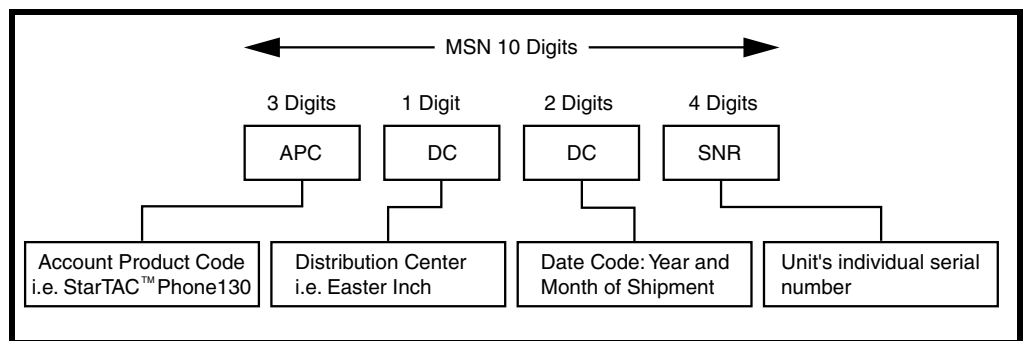

000807a

Figure 19. MSN Label Breakdown

International Mobile Station Equipment Identity (IMEI)

The International Mobile station Equipment Identity (IMEI) number is an individual number unique to the PCB and is stored within the unit's memory. Figure 20 illustrates the various parts of this number.

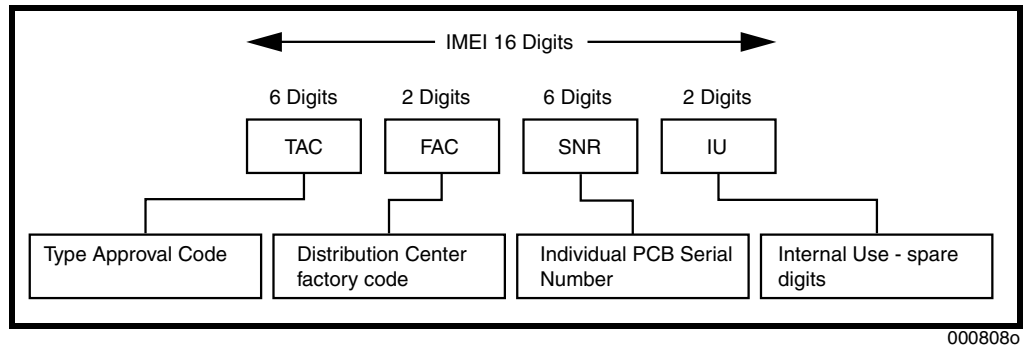

Figure 20. IMEI Label Breakdown

Other label number configurations present are:

- **TRANSCIVER NUMBER:** Identifies the product type. Normally the SWF number. (i.e. V100).
- **PACKAGE NUMBER:** Identifies the equipment type, mode, and language in which the product is shipped.

Troubleshooting

Manual Test Mode

Motorola PF B65 telephones are equipped with a manual test mode capability. This allows service personnel to verify functionality and perform fault isolation by entering keypad commands.

To enter the manual test command mode, a GSM/DCS test SIM must be used.

1. Turn the phone OFF.
2. Remove the battery as described in the procedures.
3. Remove the customer's SIM card from the phone as described in the procedures.
4. Insert the test SIM into the SIM slot.
5. Replace the battery as described in the procedures.
6. Turn the phone ON.

Manual Test Mode Commands

Table 3. Manual Test Commands

Key Sequence	Test Function/Name	Remarks
<Menu>048263*	Enter manual test mode	
"End" Key	Exit manual test mode	
54*	Suspend	Required for all Test Mode Operations
0*0*0	Select tone 0	
0*0*1	Select tone 1	
0*0*2	Select tone 2	
0*0*3	Select tone 3	
0*0*4	Select tone 4	
0*0*5	Select tone 5	
0*0*6	Select tone 6	
0*0*7	Select tone 7	
0*0*8	Select tone 8	
0*0*9	Select tone 9	
0*1*X	Disable tone X	
3*0*1	Enable vibrator	
3*0*0	Disable vibrator	
5*0*0	Set audio level 0	
5*0*1	Set audio level 1	
5*0*2	Set audio level 2	
5*0*3	Set audio level 3	
5*0*4	Set audio level 4	
5*0*5	Set audio level 5	
5*0*6	Set audio level 6	
5*0*7	Set audio level 7	

Table 3. Manual Test Commands (Continued)

Key Sequence	Test Function/Name	Remarks
5*0*8	Set audio level 8	
5*0*9	Set audio level 9	
5*0*10	Set audio level 10	
5*0*11	Set audio level 11	
5*0*12	Set audio level 12	
5*0*13	Set audio level 13	
5*0*14	Set audio level 14	
5*0*15	Set audio level 15	
6*2*2*0*0	Set Audio Path. Int Mic, IntSpk, RX unmute, TX unmute	
6*4*6*0*0	Set Audio Path. Boom Mic, Boom Spk, RX unmute, TX unmute	
10*0*3	Set band GSM 900	
10*0*4	Set band DCS 1800	
10*0*5	Set band PCS 1900	
10*0*6	Set dual band GSM 900/1800	
10*1*0	Read band	3= GSM 4= DCS 5= PCS 6 =GSM/DCS
18*0	Initialize non-volatile memory (Master Reset)	
18*1	Initialize non-volatile memory (Master Clear)	
55*2*001	Test Display. All pixels ON	
55*2*000	Test Display. All pixels OFF	
55*2*002	Test Display. Checkerboard pattern A	
55*2*003	Test Display. Checkerboard pattern B	
55*2*004	Test Display. Border pixels ON	
*#06#	IMEI Check	No Test Mode Required
Phone Set up --> Phone Status --> Other Information	Flex Version/Technology/S-W Version/Readiness Status	No Test Mode Required

Troubleshooting Chart

Table 4. PF B65 Telephone: Level 1 and 2 Troubleshooting Chart

Symptom	Probable Cause	Verification and Remedy
1. Telephone will not turn on or stay on.	a) Battery either discharged or defective.	Measure battery voltage across a 50 ohm (>1 Watt) load. If the battery voltage is <3.25 Vdc, recharge the battery using the appropriate battery charger. If the battery will not recharge, replace the battery. If battery is not at fault, proceed to b.
	b) Battery connectors open or misaligned.	Visually inspect the battery connectors on both the battery and the telephone. Realign and, if necessary, either replace the battery or refer to a Level 3 Service Center for the battery connector replacement. If battery connectors are not at fault, proceed to c.
	c) Transceiver board assembly defective.	Remove the transceiver board assembly. Substitute a known good assembly and temporarily reassemble the unit. Depress the PWR button; if unit turns on and stays on, disconnect the dc power source and reassemble the telephone with the new transceiver board assembly. Verify that the fault has been cleared. If the fault has not been cleared then proceed to d.
	d) keyboard assembly failure.	Replace the keyboard assembly. Temporarily connect a +3.6 Vdc supply to the battery connectors. Depress the PWR button. If unit turns on and stays on, disconnect the dc power source and reassemble with the new keyboard assembly.
2. Telephone exhibits poor reception or erratic operation such as calls frequently dropping or weak or distorted audio.	a) Antenna assembly defective.	Check to make sure that the antenna pin is properly connected to the transceiver board assembly. If connected properly, substitute a known good antenna. If the fault is still present, proceed to b.
	b) Transceiver board assembly defective.	Replace the transceiver board assembly (refer to 1c). Verify that the fault has been cleared and reassemble the unit with the new transceiver board assembly.
3. Display is erratic, or provides partial or no display.	a) Transceiver board connections faulty.	Remove rear chassis assembly from unit, check general condition of flexible printed cable (flex). If the flex is good, check that the flex connector is fully pressed down. If not, check connector to transceiver board connections. If faulty connector, replace the transceiver board assembly. If connector is not at fault, proceed to b.
	b) Flip assembly defective.	Temporarily replace the flip assembly with a known good assembly. If fault has been cleared, reassemble with the new flip assembly. If fault not cleared, proceed to c.
	c) Transceiver board assembly defective.	Replace the transceiver board assembly (refer to 1c). Verify that the fault has been cleared and reassemble the unit with the new transceiver board assembly.
4. Incoming call alert transducer audio distorted or volume is too low.	Faulty transceiver board assembly.	Replace the transceiver board assembly (refer to 1c). Verify that the fault has been cleared and reassemble the unit with the new transceiver board assembly.

Table 4. PF B65 Telephone: Level 1 and 2 Troubleshooting Chart (Continued)

Symptom	Probable Cause	Verification and Remedy
5. Telephone transmit audio is weak. (usually indicated by called parties complaining of difficulty in hearing voice).	a) Microphone connections to the transceiver board assembly defective.	Gain access to the microphone as described in the procedures. Check connections. If connector is faulty proceed to c; if the connector is not at fault, proceed to b.
	b) Microphone defective.	Gain access to microphone. Disconnect and substitute a known good microphone. Place a call and verify improvement in transmit signal as heard by called party. If good, reassemble with new microphone. If microphone is not at fault, reinstall original microphone and proceed to c.
	c) Transceiver board assembly defective.	Replace the transceiver board assembly (refer to 1c). Verify that the fault has been cleared and reassemble the unit with the new transceiver board assembly.
6. Receive audio from earpiece speaker is weak or distorted.	a) Connections to or from transceiver board assembly defective.	Gain access to the transceiver board assembly as described in the procedures. Check flex and the flex connector from the flip assembly to the transceiver board assembly. If flex is at fault, replace flip assembly. If flex connector is at fault, proceed to d. If connection is not at fault, proceed to b.
	b) Flip assembly defective.	Temporarily replace the flip assembly with a known good assembly. If fault has been cleared, reassemble with the new flip assembly. If fault not cleared, proceed to c.
	c) Antenna assembly defective.	Check to make sure the antenna is installed correctly. If the antenna is installed correctly, substitute a known good antenna assembly. If this does not clear the fault, reinstall the original antenna assembly and proceed to d.
	d) Transceiver board assembly defective.	Replace the transceiver board assembly (refer to 1c). Verify that the fault has been cleared and reassemble with the new transceiver board assembly.
7. Telephone will not recognize or accept SIM.	a) SIM defective.	Check the SIM contacts for dirt. Clean if necessary and check if fault has been cleared. If the contacts are clean, insert a known good SIM into the telephone. Power up the unit and confirm that the SIM has been accepted. If the fault no longer exists, replace the defective SIM. If the SIM is not at fault, proceed to b.
	b) Flip assembly defective.	Temporarily replace the flip assembly with a known good assembly. If fault has been cleared, reassemble with the new flip assembly. If fault not cleared, proceed to c.
	c) Transceiver board assembly defective.	Replace the transceiver board assembly (refer to 1c). Verify that the fault has been cleared and reassemble the unit with the new transceiver board assembly.
8. Phone does not sense when flip is opened or closed (usually indicated by inability to answer incoming calls by opening the flip, or inability to make outgoing calls).	a) Flip assembly defective.	Temporarily replace the flip assembly with a known good assembly. If fault has been cleared, reassemble with the new flip assembly. If fault not cleared, proceed to b.
	b) Transceiver board assembly defective.	Replace the transceiver board assembly (refer to 1c). Verify that the fault has been cleared and reassemble the unit with the new transceiver board assembly.

Table 4. PF B65 Telephone: Level 1 and 2 Troubleshooting Chart (Continued)

Symptom	Probable Cause	Verification and Remedy
9. Vibrator feature not functioning.	Transceiver board assembly defective.	Replace the transceiver board assembly (refer to 1c). Verify that the fault has been cleared and reassemble the unit with the new transceiver board assembly.
10. Internal Charger not working.	Faulty charger circuit on transceiver board assembly.	Test a selection of batteries in the rear pocket of the desktop charger. Check LED display for the charging indications. If these are charging properly, then the internal charger is at fault. Replace the transceiver board assembly (refer to 1c). Verify that the fault has been cleared and reassemble the unit with the new transceiver board assembly.
11. Real Time Clock resetting when standard battery is removed.	Lithium button cell in the display board may be depleted.	Refer service to a Level 3 service center for replacement.
12. No or weak audio when using headset.	a) Headset not fully pushed home.	Ensure the headset plug is fully seated in the jack socket. If fault not cleared, proceed to b.
	b) Faulty jack socket on transceiver board assembly.	Replace the transceiver board assembly (refer to 1c). Verify that the fault has been cleared and reassemble the unit with the new transceiver board assembly.

Programming: Software Upgrade and Flexing

Contact your local technical support engineer for information about equipment and procedures for flashing and flexing. Part Number Charts

The following charts are provided as a reference for the parts associated with PF B65 telephones.

Related Publications

Motorola T720 User Guide, English

6809441A06

Exploded View Diagram

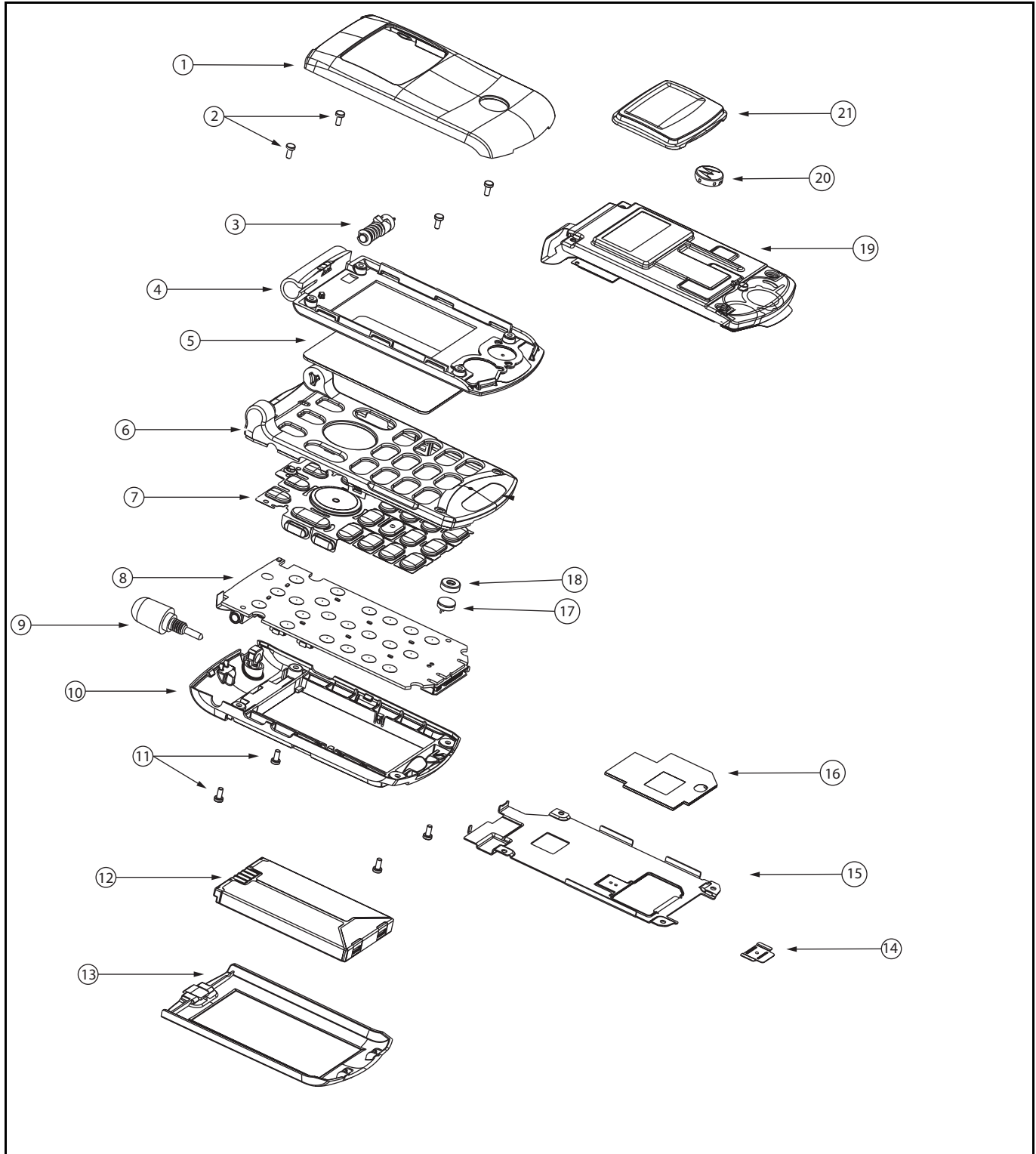

Figure 21. Exploded View

Exploded View Parts List

Table 5. Exploded View Parts List

Item Number	Motorola Part Number	Description
1	1586639K01	Flip Cover with CLI
2	0304387F03	Screws, Transceiver (4)
3	5585953C	Hinge Assembly
4	0186645K01	Flip Main Housing
5	6186580K01	Display Lens
6	0186669K01	Front Housing
7	7586600K	Keypad
8	4086609K	Popple Dome
9	8586595K01	Stubby Antenna
10	1586592K01	Back Housing, Putty Gray

Item Number	Motorola Part Number	Description
11	0304387F02	Screws, Base (4)
12	0186584K	Battery
13	0186683K01	Battery Door, 550 mAh
14	5586652K	Chassis Latch
15	2686590K	Chassis Shield
16	7586655K	Chassis SIM Box
17	5087974K	Mic
18	1486604K	Mic Boot
19	0186636K01	Flip Display Module Assembly
20	0186670K01	Flip Chassis Medallion Assembly
21	6186635K01	Flip CLI Lens Assembly



There is a danger of explosion if the Lithium Ion battery pack is replaced incorrectly. Replace only with the same type of battery or equivalent as recommended by the battery manufacturer. Dispose of used batteries according to the manufacturer's instructions.

Table 6. Postponable Housing Cover Kits

Color	Housing Kit	Battery Door Kit 550mAh Battery	Battery Door Kit 750mAh Battery	Battery Door Kit 1100mAh Battery
Astrolite Silver	SHN9009	SHN9036	SHN9050	SHN9042
Metallic Blue	SHN9016	SHN9037	SHN9051	SHN9043
Iris Blue	SHN9014	SHN9069	SHN9052	SHN9044
Silver Mint	SHN9015	SHN9038	SHN9053	SHN9045
Desert Pearl	SHN9026	SHN9039	SHN9054	SHN9046
Classic Red	SHN9027	SHN9040	SHN9055	SHN9047
Dark Indigo Metallic	SHN9028	SHN9041	SHN9056	SHN9064
Amethyst Gray	SHN9029	SHN9049	SHN9057	SHN9065
Green Metallic	SHN9030	SHN9048	SHN9058	SHN9066
Yellow Gold Metallic	SHN9031	SHN9070	SHN9059	SHN9067
Unpainted		SHN9071	SHN9060	SHN9068

Housing kits contain items 1, 2, 3, 9, 10, 14, 15, and 16. See Table 5.
Battery Door kits contain battery cover, latch, and spring.

Accessories

Table 7. Accessories

Part Description	Part Number
Battery, slim, 550 mAh	SNN5582
Battery, high performance, 750 mAh	SNN5588
Battery, extra capacity, 1100 mAh	SNN5595
Mid-Rate travel charger	SPN4992
Adapter, travel charger, Euro plug	SPN4993
Adapter, travel charger, UK plug	SPN4994
Adapter, travel charger, Brazilian plug	SPN4741
Adapter, travel charger, Argentinian plug	SPN4739
Adapter, travel charger, Korean plug	SPN4774
Adapter, travel charger, Hong Kong plug	SPN4756
Desktop charger, mallard	SPN4997
Desktop charger, mallard refresh	SPN5029
Desktop charger, mallard with insert	SPN5021
Desktop charger, loon	SPN5019
Vehicle power adapter	SYN7818
Car kit, easy install	SYN8597
Car kit, easy install, puck	SYN9169
Car kit, pro install, digital	S9609
Car kit, pro install, analog	S9610
Speakerphone attachment	SPN5028
Headset, FM stereo radio	SYN8609
Headset, dual, retractable	SYN8284
Headset, single, retractable	SYN9050
Headset, send / end button	SYN9351
Headset, over the ear	SYN8908
Headset, silver	AAYN4264
Neckloop, hands-free (compatible with T-coil hearing aids)	SYN7875
Speaker, hands-free clip-on	SYN8610
Desktop station, hands-free	SYN8596
Data kit, USB	S8951
Data kit, serial multi-connect	S8952
Data kit, serial multi-connect for Palm™ III/V	S8953
Data cable, USB	SKN6311
Data cable, serial	SKN6315
Data cable, serial for Palm™ III	SKN6320
Data head, serial	SYN0279
Belt clip, black	SYN8763
Holster, rotating	1586679K01

MOTOROLA, the Stylized M Logo, and all other trademarks indicated as such herein are trademarks of Motorola, Inc.
® Reg. U.S. Pat. & Tm. Off.
TrueSync and Starfish are registered trademarks of Starfish, Inc., a wholly owned independent subsidiary of Motorola, Inc.
All other product or service names are the property of their respective owners.

© 2002 Motorola, Inc.
All rights reserved.
Personal Communications Sector,
1500 Gateway Blvd.
Boynton Beach, FL 33426-8292



6881040B60-O

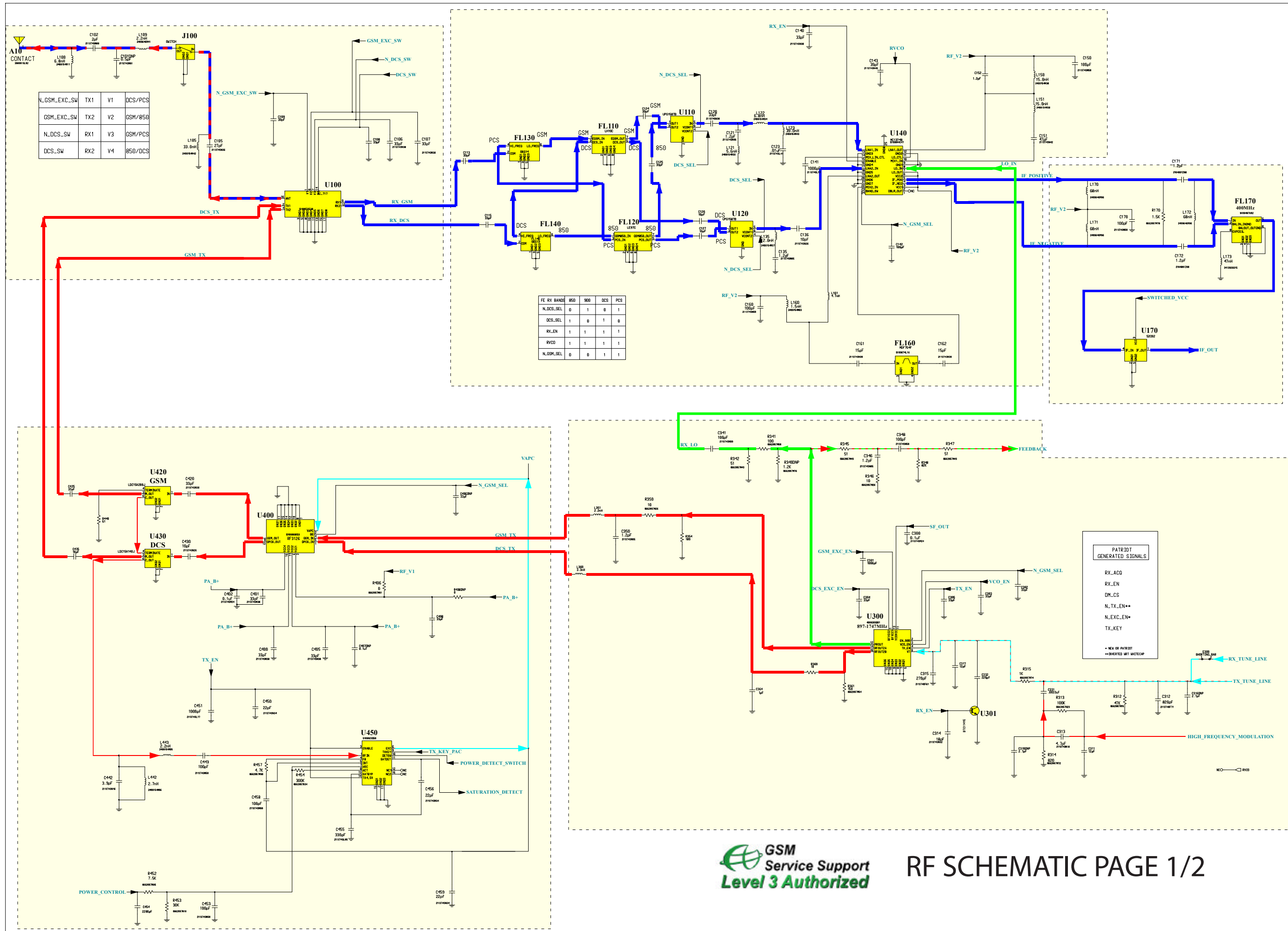

BOARD LAYOUT - PAGE 2/2

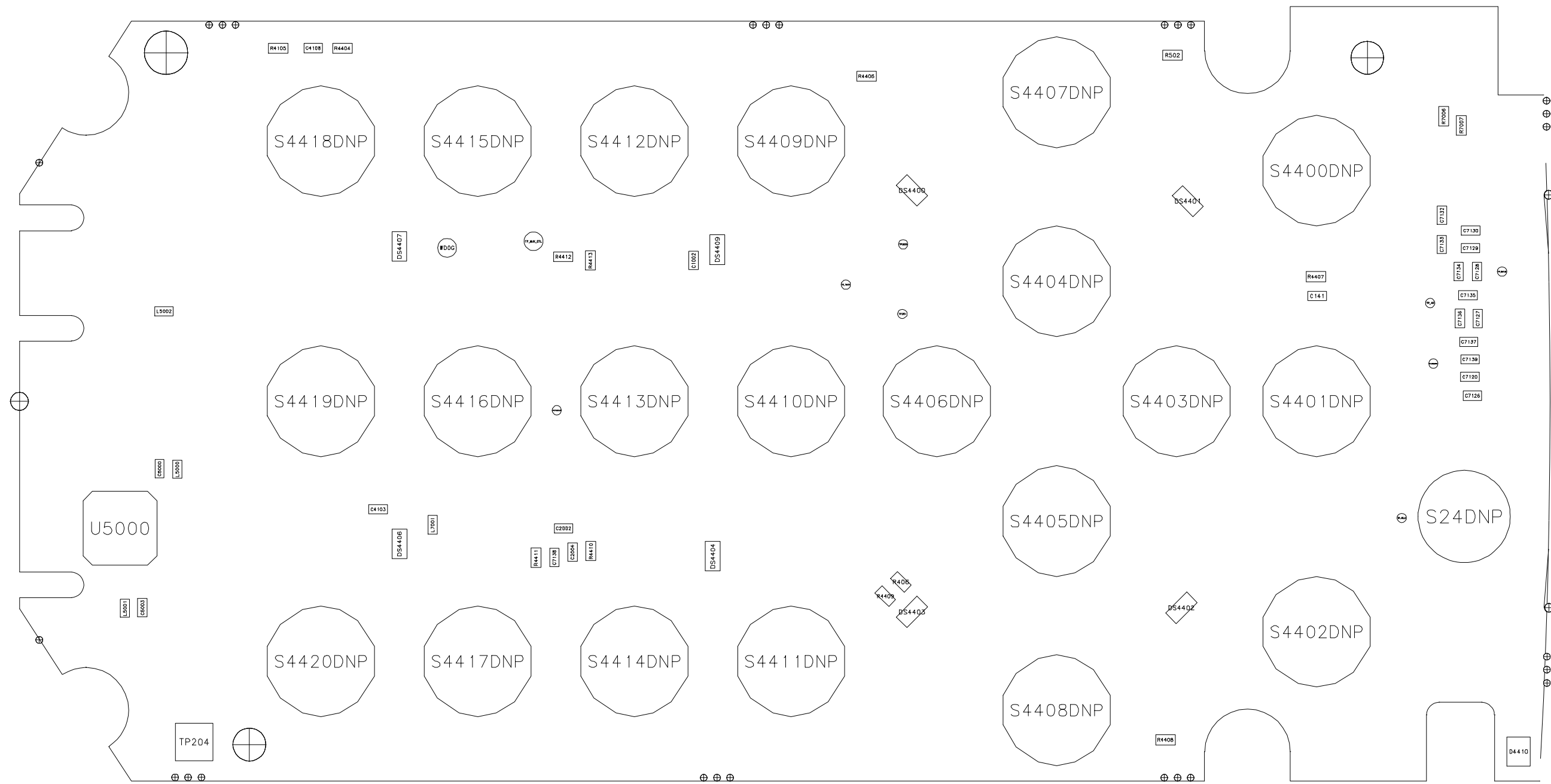

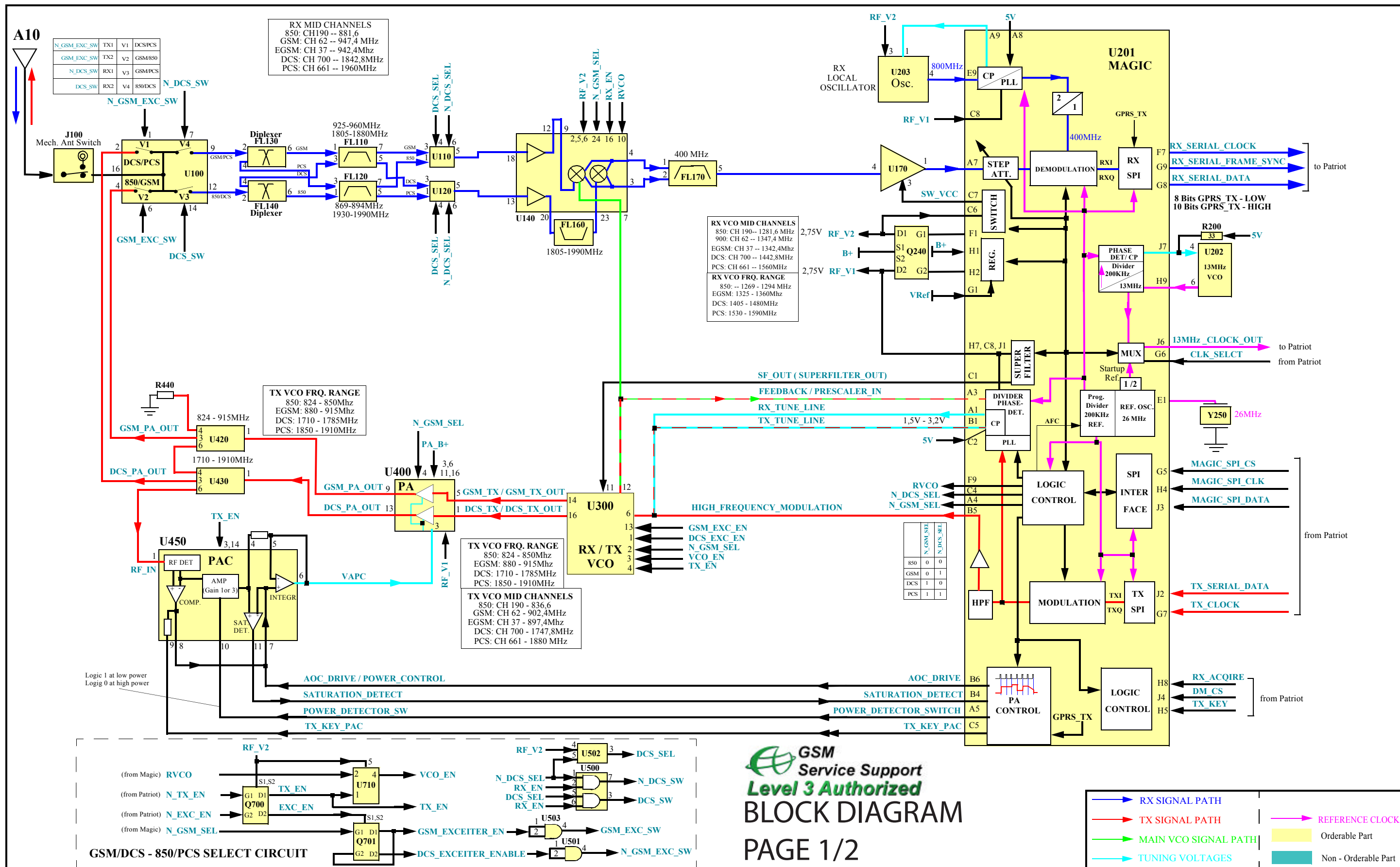

GSM Service Support
 Level 3 Authorized
 BLOCK DIAGRAM
 PAGE 1/2

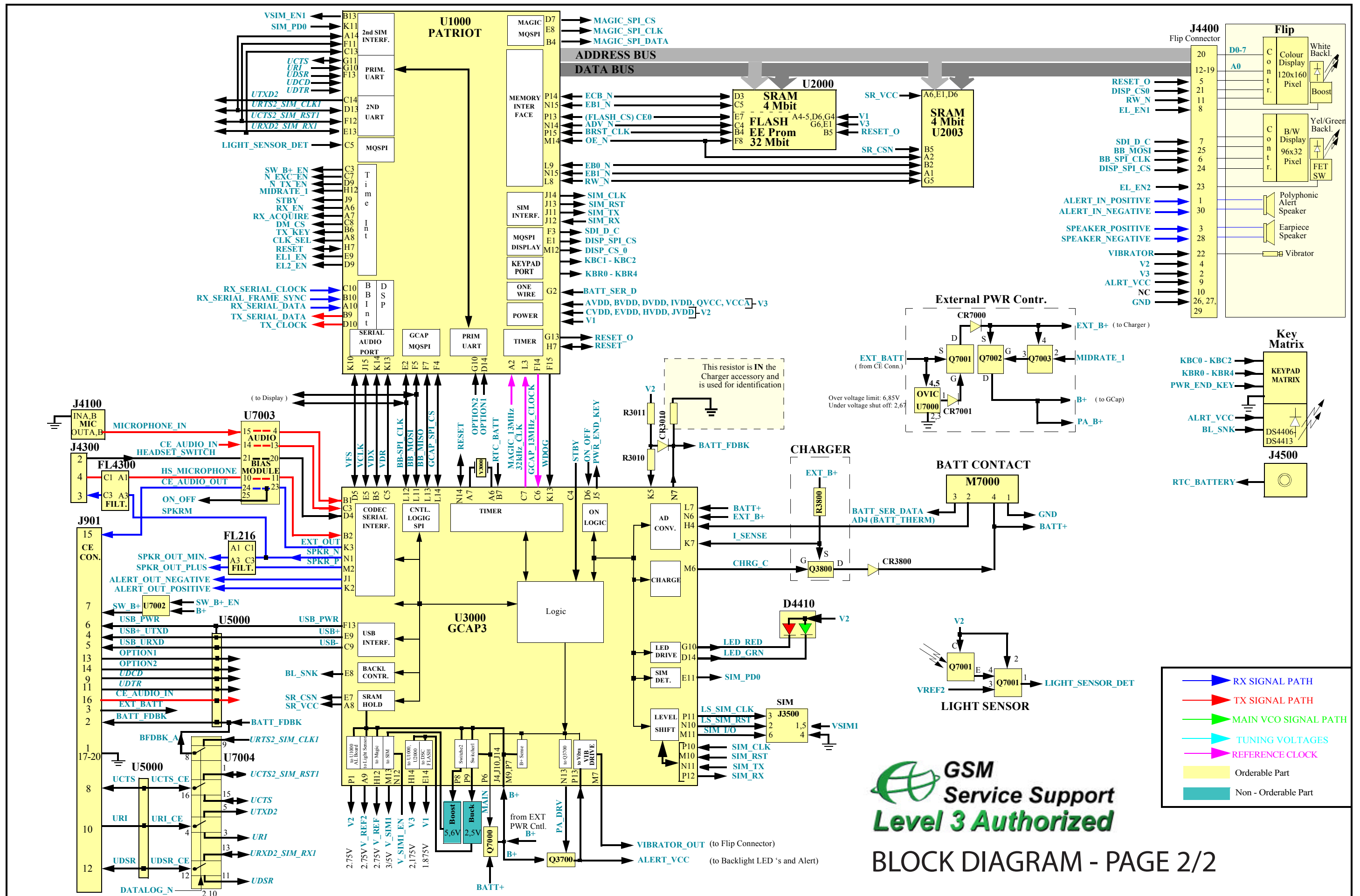

GSM
Service Support
Level 3 Authorized

BLOCK DIAGRAM - PAGE 2/2